

Canon



BUBBLE JET PRINTER

S300

User's Guide

Table of Contents



Introduction	5
How to Use This Manual	6
Safety Precautions	8
Printer Parts and Their Functions	14
Front View	15
Rear View	16
Inside the Printer	17
Operation Panel	18
Printer Driver Functions (Windows)	19
Opening the Printer Properties Dialog Box	20
Printer Properties Dialog Box Description	22
BJ Status Monitor Functions	35
Canceling a Print Job	38
Uninstalling Printer Drivers	39
Printer Driver Functions (Macintosh)	40
Description of Print Settings	41
BJ Print Monitor	57
Canceling a Print Job	59

- Using the Printer with a Network 60
- Uninstalling Printer Drivers 64
- Routine Maintenance 65
 - When to Replace Ink Tank and Maintain Printhead 66
 - Replacing an Ink Tank 67
 - Printing the Nozzle Check Pattern 72
 - Printhead Cleaning 76
 - Printhead Deep Cleaning 79
 - Enabling Low Ink Warning 81
 - Transporting the Printer 87
- Printing Media 91
 - Compatible Media Types 92
 - Envelopes 94
 - High Resolution Paper HR-101N 98
 - Glossy Photo Paper GP-301N/GP-301 100
 - High Gloss Photo Film HG-201 102
 - Glossy Photo Cards FM-101 104
 - Photo Paper Pro PR-101 106
 - Photo Paper Pro PC-101S 108
 - Transparencies CF-102 110
 - T-Shirt Transfers TR-201 112
 - Banner Paper 114
- Troubleshooting 117
 - Cannot Install the Printer Driver 118
 - Print Quality is Poor or Contains Errors 120

Printer Does Not Start or Stops During Print Jobs	137
Paper Does Not Feed Properly or Paper Jams	143
The POWER Lamp Flashes Orange	147
An Error Message is Displayed on the Screen	150
Low Ink Warning Displays Ink Tank with '?'	159
Problems Unique to Windows	162
Problems Unique to the Macintosh	165
Specifications	168
Index	182

Introduction

Thank you for purchasing the Canon S300 Bubble Jet Printer. This User's Guide provides complete explanations of the features and functions of the printer. This guide uses the following symbols to indicate important information. Always observe these instructions.

Warning ➤ Instructions that, if ignored, could result in death or serious personal injury caused by incorrect operation of the equipment. These must be observed for safe operation.

Caution ➤ Instructions that, if ignored, could result in personal injury or material damage caused by incorrect operation of the equipment. These must be observed for safe operation.

Important ➤ Prohibited actions that, inadvertently performed, could result in equipment damage, faults or impaired product quality. These must be avoided for correct operation.

Windows

Information for Windows® only.

Macintosh

Information for Macintosh® only.

How to Use This Manual

To view this User's Guide, we recommend that you use Acrobat® Reader™ 4.0 or Acrobat Reader 3.0. Please note that screens displayed by Acrobat Reader 3.0 are slightly different.

 Use this button to enlarge the viewing screen. Select this button in the tool bar and click within the screen.

 Displays the previous page.

 Displays the next page.

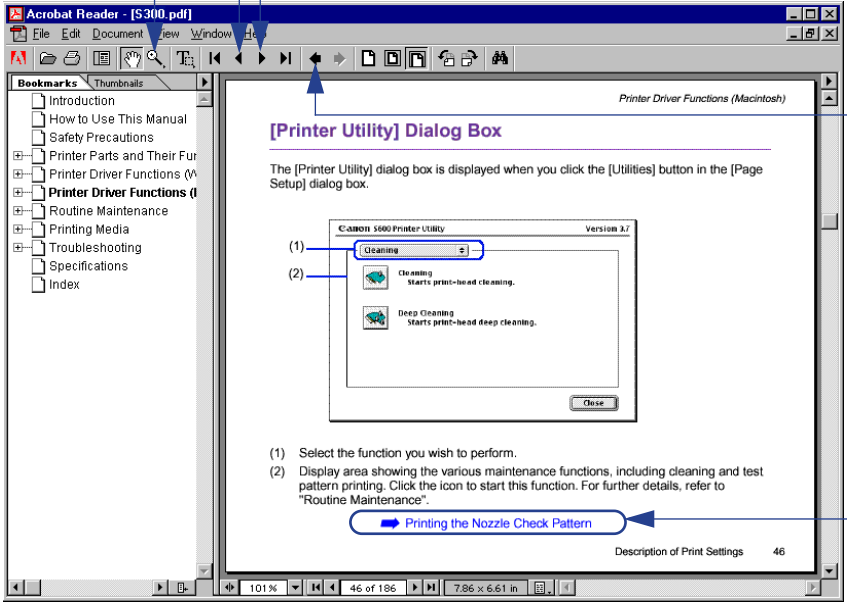

 Returns to the page you were previously viewing.

Click to jump straight to this page.

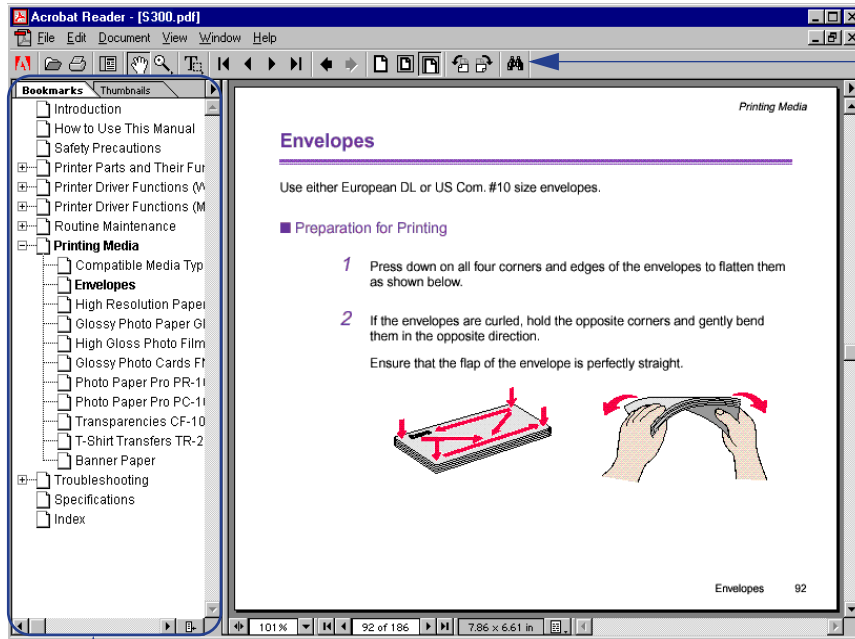

 Use this button to search for a word.

Displays the table of contents.
Click the heading to jump to the topic.
Click the "+" symbol to see the headings for each chapter.
Click the "□" symbol to close the headings.

Safety Precautions

Please read the safety warnings and cautions provided in this manual to ensure that you use the printer safely. Do not attempt to use the printer in any way not described in this manual.

Warning ► You may cause an electric shock/fire or damage the printer if you ignore any of these safety precautions.

■ Choosing a location

Do not place the printer close to flammable solvents such as alcohol or thinners.

■ Power supply

Never attempt to plug in or unplug the printer from the power supply when your hands are wet.

Always push the plug all the way into the power outlet.

Never damage, modify, stretch or excessively bend or twist the power cord. Do not place heavy objects on the power cord.

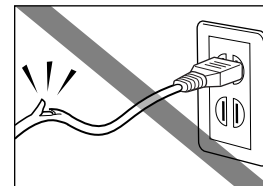

Never plug the printer into a power socket that is shared with other equipment (extension cord, double adapter, etc.).

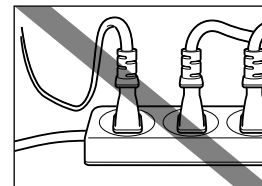

Never use the printer if the power cord is bundled or knotted.

If you detect smoke, unusual smells or strange noises around the printer, immediately unplug the printer at the power supply and call for service.

Periodically unplug the printer and use a dry cloth to wipe off any dust or dirt that has collected on the plug and power outlet. If the printer is placed in a location exposed to a lot of dust, smoke or high humidity, the dust that has collected on the plug may absorb moisture and cause insulation failure and fire.

■ Cleaning the printer

Use a damp cloth to clean the printer. Never use flammable solvents such as alcohol, benzene or thinners.

If flammable solvents come in contact with electrical components inside the printer, it could cause a fire or electric shock.

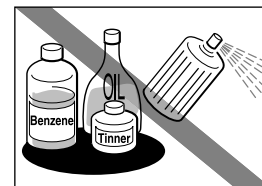

Always unplug the printer from the power outlet before cleaning the printer.

If you accidentally switch the printer on while cleaning it, you could injure yourself or damage the printer.

■ Maintaining the printer

Do not attempt to disassemble or modify the printer. There are no user-serviceable parts inside the printer.

The printer contains high-voltage components. Never attempt any maintenance procedure not described in this guide.

■ Working around the printer

Do not use flammable sprays near the printer.

This could cause a fire or electric shock if the spray comes into contact with electrical components inside the printer.

Never put your hands or fingers in the printer while it is printing.

Do not place metal objects (paper clips, staples, etc.) or containers of flammable solvents (alcohol, thinners, etc.) on top of the printer.

If any foreign object (metal or liquid) falls into the printer, unplug the power cord and call for service.

Caution ➤ You may cause injury or damage the printer if you ignore any of these safety precautions.

■ Choosing a location

Do not install the printer in a location that is unstable or subject to excessive vibration.

Do not install the printer in a location that is very humid or dusty, in direct sunlight, outdoors, or close to a heating source.

To avoid the risk of fire or electric shocks, install the printer in a location with an ambient temperature range of 41°F to 95°F (5°C to 35°C) and humidity of 10% to 90% (condensation free).

Do not place the printer on a thick rug or carpet.

Ensure that the area around the power outlet is kept clear at all times so you can easily unplug the power cord if necessary.

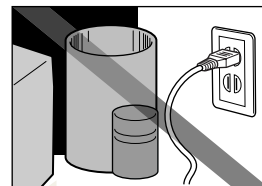

When moving the printer, carry the printer at both ends.

■ Power supply

Never remove the plug by pulling on the cord.

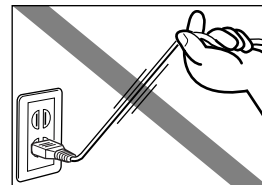

Do not use an extension cord.

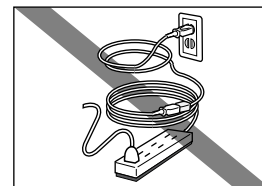

If you do not intend to use the printer for a long period of time, unplug it after turning it off.

Never use a power supply voltage other than that supplied in the country of purchase.

The correct power supply voltage and frequency is as follows:

USA/Canada: AC 120V, 60Hz

Europe: AC 230V \pm 10%, 50Hz

Australia: AC 240V, 50Hz

■ Printheads and ink tanks

For safety reasons, store printheads and ink tanks out of the reach of small children.

If a child ingests any ink, consult a doctor immediately.

Do not shake printheads or ink tanks.

Ink may leak out and stain clothing or the surrounding area.

Never touch the electrical contacts on a printhead after printing.

The metal parts may be very hot and could cause burns.

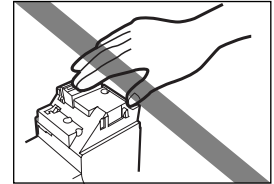

Printer Parts and Their Functions



- Front View
- Rear View
- Inside the Printer
- Operation Panel

Front View

Operation panel
For details, refer to
"Operation Panel".

Paper guide
When loading paper, ensure
that the left edge touches
this guide.
To move the paper guide,
pinch the guide and slide in
the appropriate direction.

Paper rest

Sheet feeder
Load paper here.
Paper feeds
automatically, one
sheet at a time.

Paper output tray

Front cover
Open to replace the
ink tanks or remove
jammed paper.

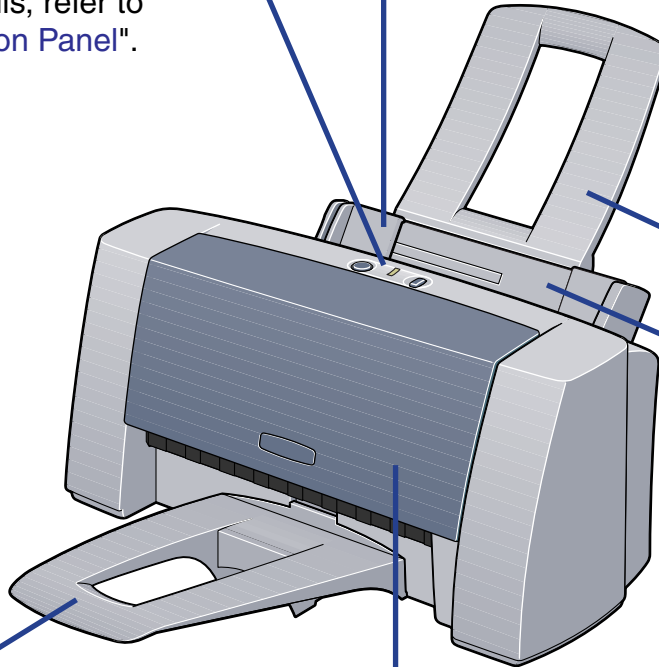

Rear View

USB port

Connects the printer to a computer through a USB port.

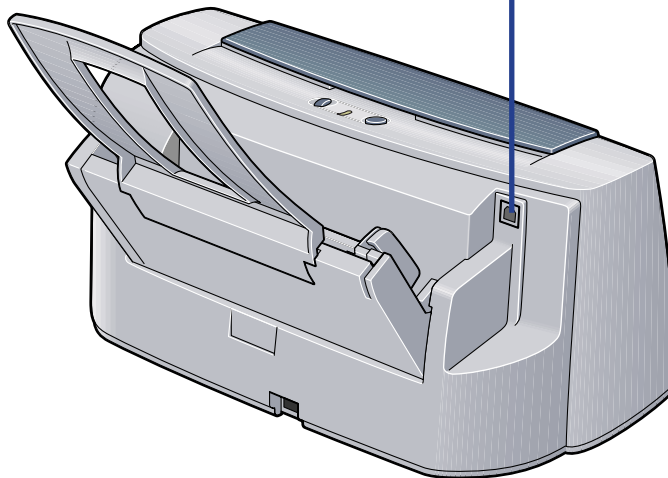

Inside the Printer

Paper thickness lever

Adjusts the gap between the printhead and the surface of the printing paper.

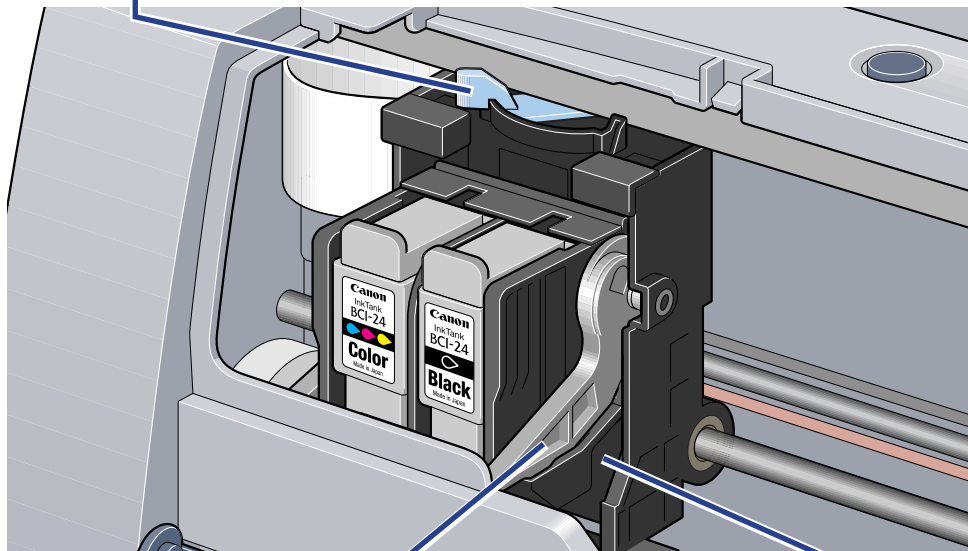

Printhead lock lever

Locks the printhead into the holder.
Once the printhead is installed, do not touch this lever.

Printhead holder

Install the printhead here.

Operation Panel

POWER button

Press to turn the printer on or off. The printer will initialize, then print.

RESUME/CANCEL button

Press to resume printing once an error has been resolved. To cancel printing in progress, press this button.

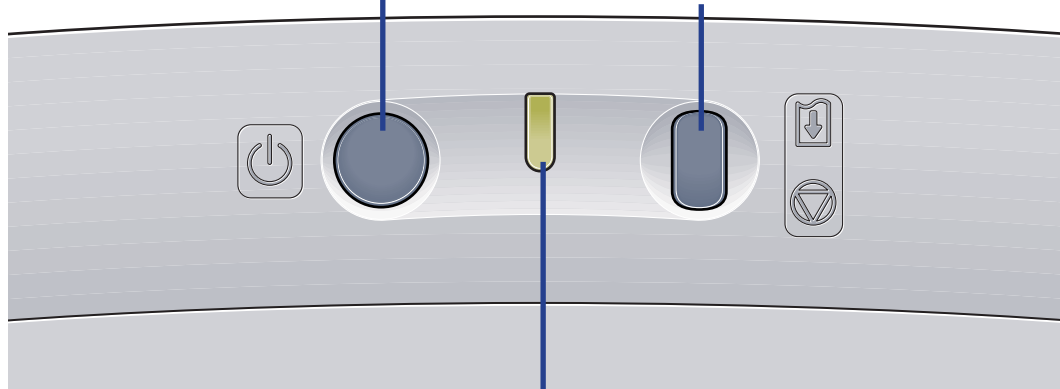

POWER lamp

Off: The printer is turned off.

Green: The printer is ready to print.

Flashing green: The printer is preparing to print, or is currently printing.

Flashing orange (two or more between green flashes): An error has occurred and the printer is not ready to print.

Flashing orange and green alternately: An error has occurred that will require you to contact the Customer Care Center.

Printer Driver Functions (Windows)

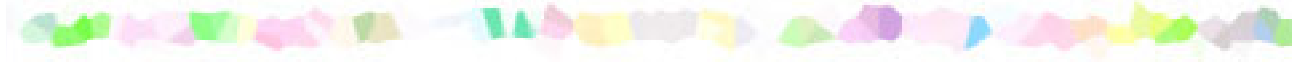

- Opening the Printer Properties Dialog Box
- Printer Properties Dialog Box Description
- BJ Status Monitor Functions
- Canceling a Print Job
- Uninstalling Printer Drivers

Opening the Printer Properties Dialog Box

The Printer Properties dialog box can be opened from within an application or directly from the Windows **Start** menu.

■ Opening the Printer Properties dialog box from your application program

This method is generally used to specify printer settings just before printing. The operations may vary slightly depending on your application program. This section describes only the general procedure for opening the Printer Properties dialog box.

1 In your application, select the command to print a document.

The **Print** dialog box can usually be opened by selecting **Print** from the **File** menu.

2 Ensure that **Canon S300** is selected in the **Name** field, then click **Properties**.

The Printer Properties dialog box will appear.

Note ➤ Depending on your application program, the command and menu names may differ, and there may be more steps involved in opening the Printer Properties dialog box. For further details, see the user's manual for your application.

■ Opening the Printer Properties dialog box directly from the **Start** menu

This method is used for maintenance operations such as printhead cleaning, or to specify printer settings common to all application programs.

When the Printer Properties dialog box is opened from the **Start** menu, additional tabs appear, including the **Details** tab. These do not appear when the Printer Properties dialog box is opened from within an application.

For further information about these additional tabs, refer to your Windows documentation.

1 Click **Start**, then select **Settings**, then **Printers**.

For Windows XP, click **Start**, then **Control Panel**, then **Printers and Other Hardware**, then **Printers and Faxes**.

2 Select the **Canon S300** icon.

3 Open the **File** menu and select:

- Windows 98/Windows Me → **Properties**
- Windows 2000/Windows XP → **Printing Preferences**

The Printer Properties dialog box will open.

Printer Properties Dialog Box Description

The image shows a screenshot of the 'Car on S300 Properties' dialog box. The dialog box has a title bar with the text 'Car on S300 Properties' and standard window controls. Below the title bar is a tabbed interface with the following tabs: Main, Page Setup, Stamp/Background, Effects, Profiles, and Maintenance. The 'Main' tab is currently selected and highlighted. The main area of the dialog box contains several settings:

- Media Type:** Plain Paper (dropdown menu)
- Paper Source:** Auto Sheet Feeder (dropdown menu)
- Print Quality:** Standard (radio button selected), High, Draft, Custom (radio buttons), with a 'Set...' button.
- Color Adjustment:** Auto (radio button selected), Manual (radio button), with a 'Set...' button.
- Grayscale Printing:** A checkbox that is currently unchecked.
- Left Panel:** Contains a printer icon, a 'Print Advisor...' button, and a list of settings: Letter, Normal-size Printing, Stamp: None, Background: None, Effects: None.
- Bottom Buttons:** About, Defaults, OK, Cancel, Apply, Help.

Blue lines with circular endpoints point from the following list to the corresponding tabs in the dialog box:

- Main Tab
- Page Setup Tab
- Stamp/Background Tab
- Effects Tab
- Profiles Tab
- Maintenance Tab

Note ➤ The screens in this section refer to Windows 98/Windows Me operation. The equivalent screens for Windows 2000 and Windows XP may look slightly different.

Main Tab

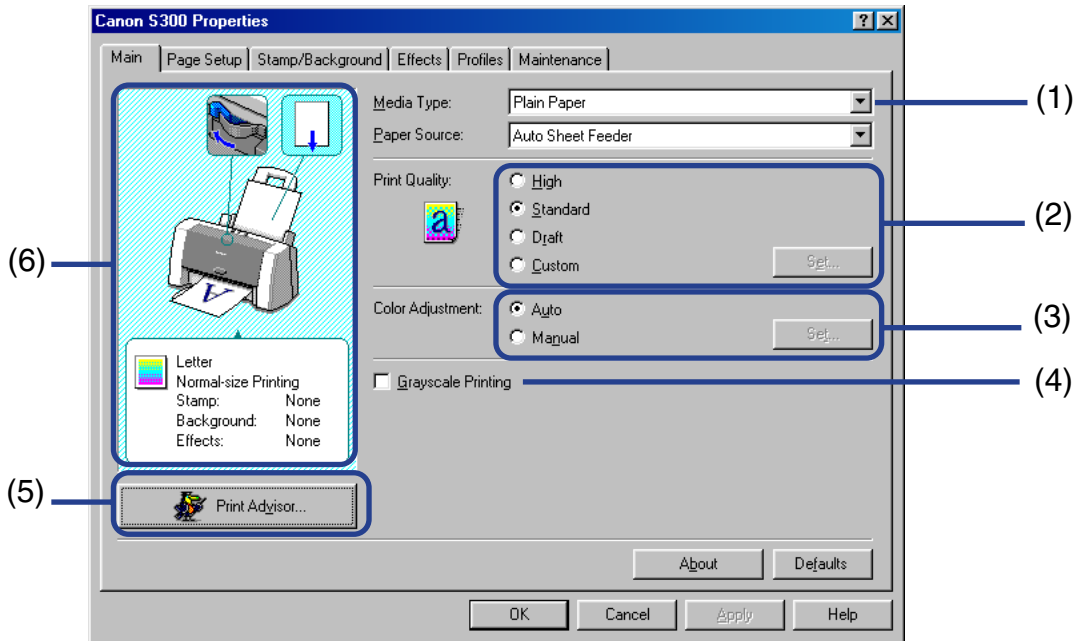

- (1) **Media Type**
Ensure that this setting matches the type of media loaded in the printer.
- (2) **Print Quality**
Select the print quality you require from among the different options. For a custom print quality, select **Custom**, then click **Set**.

(3) **Color Adjustment**

Select the method of color adjustment. To make detailed color adjustments, select **Manual**, then click **Set**.

(4) **Grayscale Printing**

Select to print a grayscale version of a color document.

(5) **Print Advisor**

Click to start the Print Advisor.

The Print Advisor simplifies configuration of the printer driver. By having the user answer a series of questions, the Printer Advisor automatically configures the printer driver settings.

(6) **Preview area**

Before printing, verify that settings such as the lever position are correct.

Note ➤ To see a description of any item in the Printer Properties dialog box, click the **?** mark, then click the desired item. To see a description of operating procedures, click **Help**. If **Help** does not appear when using Windows 2000 or Windows XP, click **Start**, then select **Programs** (or **All Programs**), then **Canon S300**, then **Guide**.

Page Setup Tab

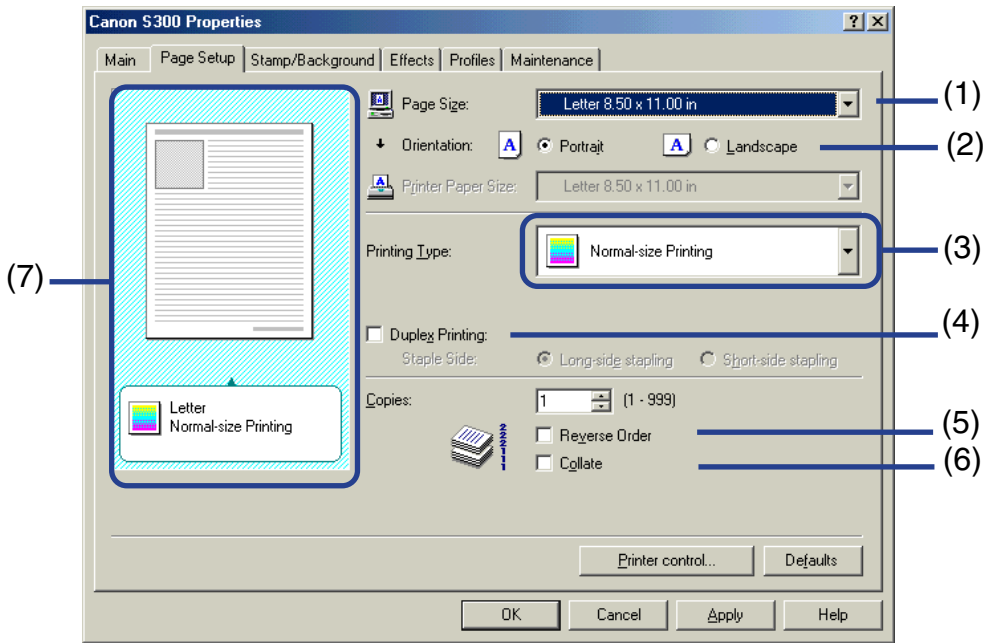

- (1) **Page Size**
Ensure that the correct paper size is selected.
- (2) **Orientation**
Select landscape or portrait printing and ensure that it is the same orientation used in the application.

(3) **Printing Type**

Select the printing method from among the following:

Normal-size Printing The document is printed according to the original dimensions. This setting is usually selected by default.

Fit to Page Printing The document is automatically resized and printed to fit into a specified page size.

Scaled Printing The document is resized when printed. When this is selected, you can specify the **Printer Paper Size** and **Scaling**.

Page Layout Printing Pages are reduced and printed so that multiple document pages fit on each printed page.

Poster Printing This enlarges and splits the print image across several sheets of paper. The printed sheets can then be assembled to make a large poster.

Banner Printing Select this when printing on banner paper.

(4) **Duplex Printing**

The document is printed on both sides of the paper. After printing on one side, turn the ejected page over, then print on the other side.

(5) **Reverse order**

Prints the document start with the last page.

(6) **Collate**

Select to print multiple copies of the document one copy at a time.

(7) **Preview area**

Verify the overall layout, stamps, background and other settings to be applied to the print job.

Stamp/Background Tab

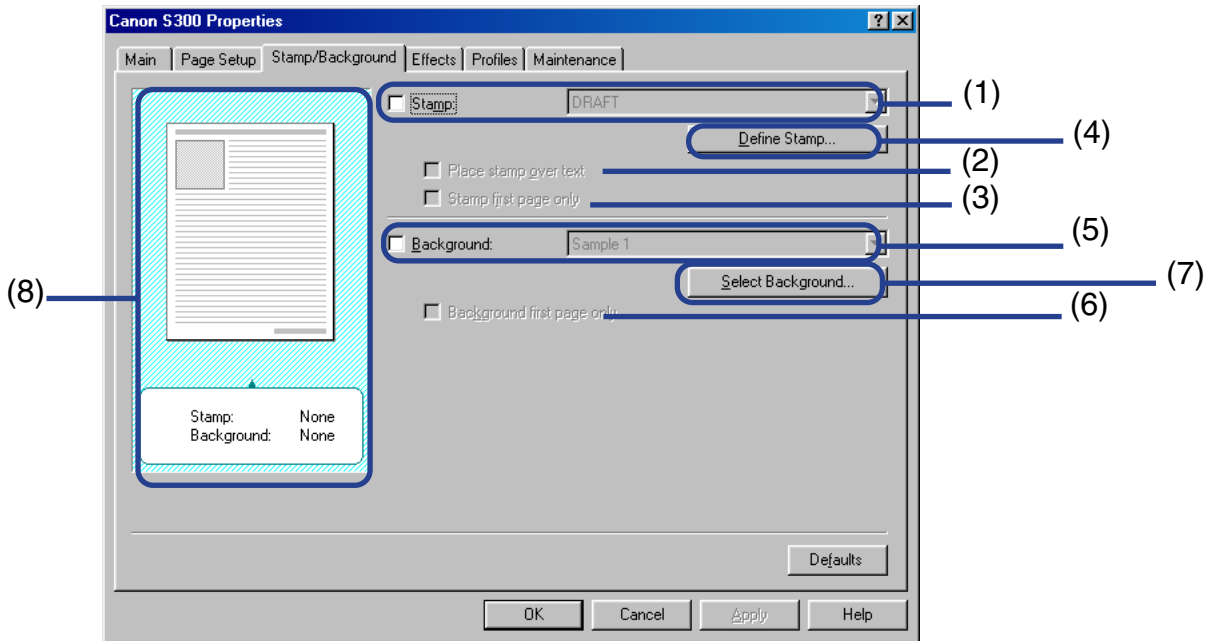

- (1) **Stamp**
Select the check box, then choose a stamp.
- (2) **Place stamp over text**
When selected, the stamp is printed over the print data.
- (3) **Stamp first page only**
When selected, the stamp is printed on the first page only.

- (4) **Define Stamp**
Use to create new stamps, or modify details for a selected stamp.
- (5) **Background**
Click to check, then choose the background image you wish to use.
- (6) **Background first page only**
When **Background** is checked, this option becomes active. When checked, the background image is printed only on the first page.
- (7) **Select Background**
Click to select a new background, or to display the details of the background you have selected.
- (8) **Preview area**

Effects Tab

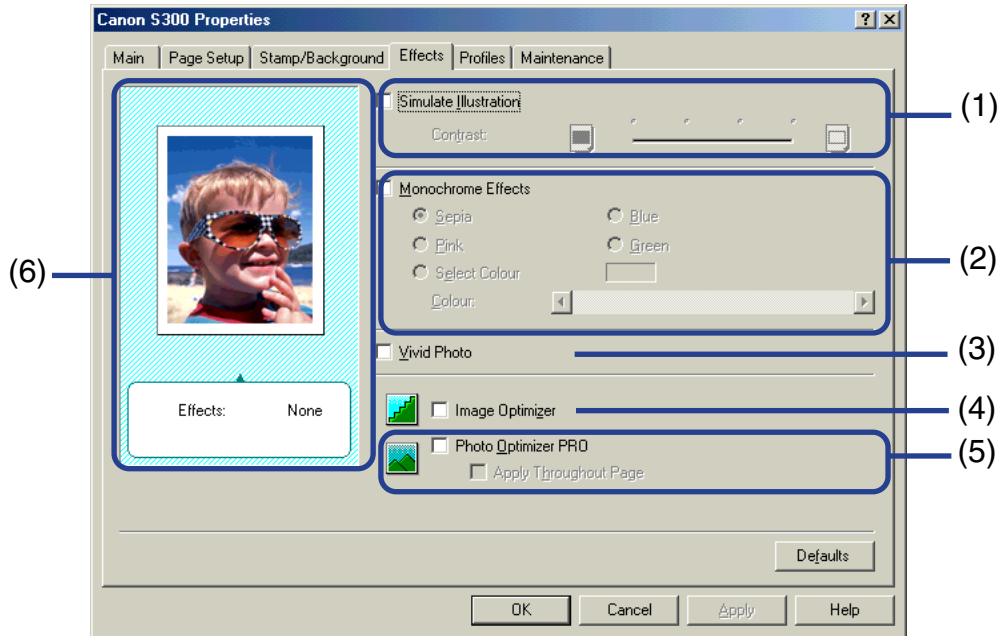

(1) Simulate Illustration

This function lets you apply graphic effects to a color image without affecting the original document. Select the check box, then adjust the image brightness with the **Contrast** slider.

(2) **Monochrome Effects**

Prints a color image in a single color. Select the check box, then choose a color or use a custom color using **Select Color**.

(3) **Vivid Photo**

With this function, you can reproduce breathtaking sceneries in which colors, especially blues and greens, appear even more vibrant. A major feature of this function is its ability to create vivid backgrounds for fields, trees, oceans, and sky while maintaining the natural skin tones of people who appear in the images.

(4) **Image Optimizer**

Improves the contours and smooths jaggedness that occurs when photographs or graphic image data is enlarged within an application.

(5) **Photo Optimizer PRO**

Optimizes the color for images taken from a digital camera or scanner. It is especially effective for images affected by color imbalance and over- or under-exposure. When printing several images on one page, optimization is usually applied to each image according to its requirements. However, if the image data has been manipulated using cut-and-paste, rotation or other such operations, group optimization of all images on the page is recommended. In such cases, select the **Apply Throughout Page** check box.

(6) **Preview area**

Profiles Tab

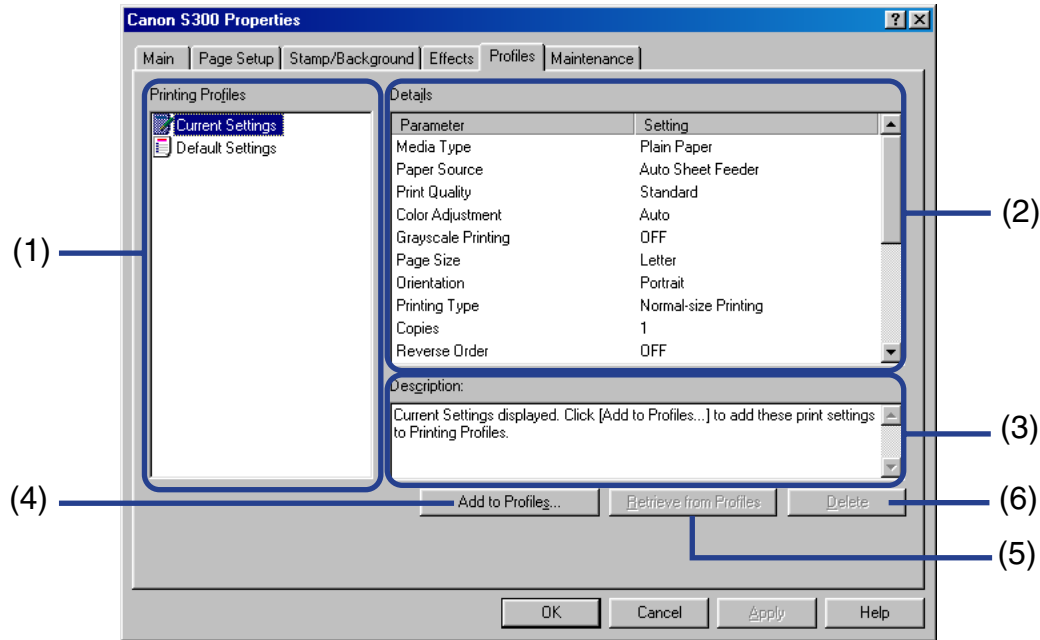

(1) Printing Profiles

Displays the printing settings currently saved in the Profiles tab.

The **Current Settings** profile contains the settings currently specified in the **Main**, **Page Setup**, **Stamp/Background** and **Effects** tabs. The **Default Settings** profile contains the factory default settings.

- (2) **Details**
Displays all the printer settings selected in **Printing Profiles**.
- (3) **Description**
Displays a description of the printer settings selected in **Printing Profiles**. You can enter the description when saving the printer settings.
- (4) **Add to Profiles**
Click to save the settings currently specified in the **Main, Page Setup, Stamp/Background** and **Effects** tabs. Select **Current Settings** in the **Printing Profiles** list, then click this button. The **Add to Profiles** dialog box will appear.
- (5) **Retrieve from Profiles**
Click to activate the selected printer profile settings. The contents of the **Main, Page Setup, Stamp/Background** and **Effects** tabs are changed when a different profile is selected. This button is disabled when **Current Settings** is selected.
- (6) **Delete**
Click to delete unwanted printer settings. Select the unwanted item in the **Printing Profiles** list, then click **Delete**. **Current Settings** and **Default Settings** cannot be deleted.

Maintenance Tab

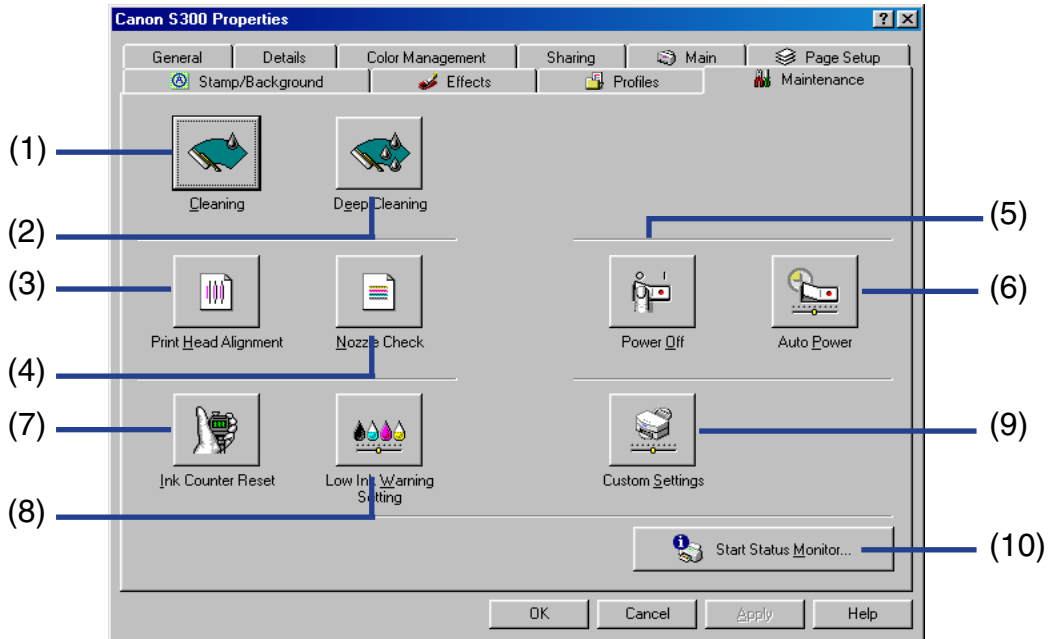

(1) **Cleaning**

Click to start printhead cleaning.

(2) **Deep Cleaning**

Click to start printhead deep cleaning.

Use this function only if **Cleaning** has not improved the print quality.

(3) **Printhead Alignment**

Click to start the printhead alignment procedure. For details on printhead alignment, refer to the printed *Quick Start Guide*.

(4) **Nozzle Check**

Click to start a nozzle check print pattern. The nozzle check ensures that printhead nozzles are outputting ink normally. For details, refer to "[Examining the Nozzle Check Pattern](#)".

(5) **Power Off**

Click to turn the printer off.

(6) **Auto Power**

Click to enable the printer to turn off automatically when no data is sent to the printer for a certain period of time, and to automatically turn the printer on again when data is sent to the printer.

(7) **Ink Counter Reset**

Click to reset the ink counter to an initial value. Set the counter every time you replace an ink tank. For details, refer to "[Enabling Low Ink Warning](#)".

(8) **Low Ink Warning Setting**

Click to enable the low ink warning function. This function must be synchronized with the ink counter to monitor ink levels. For details, refer to "[Enabling Low Ink Warning](#)".

(9) **Custom Settings**

Click to modify the printer mode. Change the settings in the **Custom Settings** dialog box, then click **Send** to change the printer mode.

(10) **Start Status Monitor**

Click to start the BJ Status Monitor, which checks and reports the printer status and the progress of printing jobs.

BJ Status Monitor Functions

The BJ Status Monitor displays the status of the printer. If an error occurs, the status monitor indicates the nature of the error and suggests an appropriate solution. When the low ink warning is enabled, the status monitor also checks the ink tanks and displays a warning message when the ink is low.

■ Launching the BJ Status Monitor

The BJ Status Monitor launches automatically when data is sent to the printer. When launched, the BJ Status Monitor will appear as an icon on the taskbar.

- 1 Click the **Canon BJ Status Monitor** icon on the taskbar.

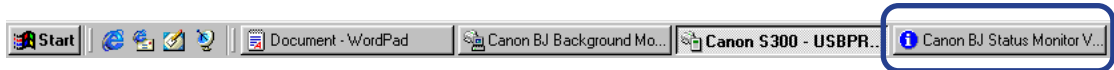

The BJ Status Monitor will appear.

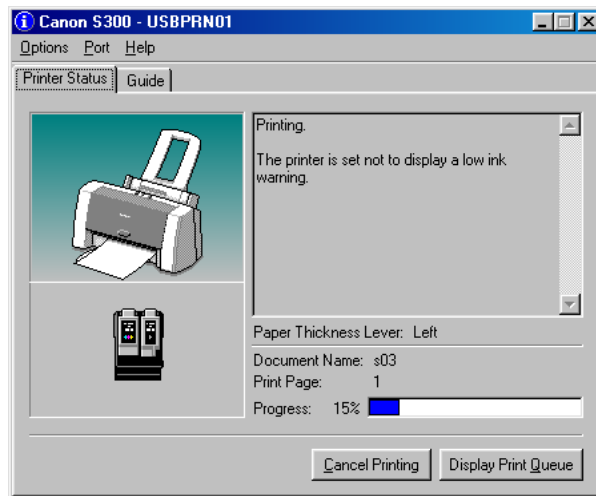

Note ➤ To open the BJ Status Monitor when the printer is not printing, click the **Maintenance** tab in the Printer Properties dialog box, then click **Start Status Monitor**.

■ When errors occur

The BJ Status Monitor is automatically displayed when an error occurs, such as if the printer runs out of paper or if the paper jams.

In such cases, take the appropriate action as described in the **Printer Status** tab.

In Windows 98 and Windows Me, click the **Guide** tab and follow the instructions on screen.

When paper has run out:

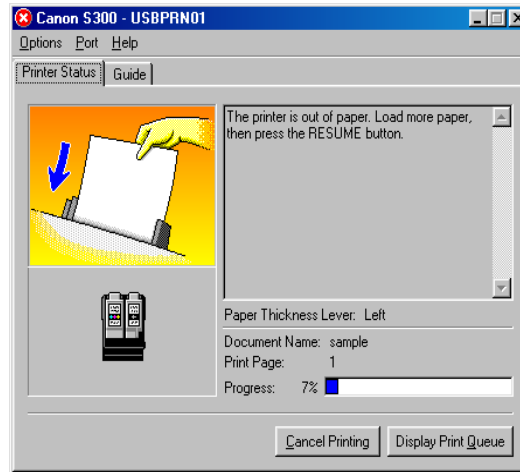

Note ➤ For details on the BJ Status Monitor, click the **Help** menu, then click the topic of interest.

Canceling a Print Job

To cancel the current print job, first open the BJ Status Monitor.

- 1 Click the **Canon BJ Status Monitor** icon on the taskbar.



- 2 Click **Cancel Printing**.

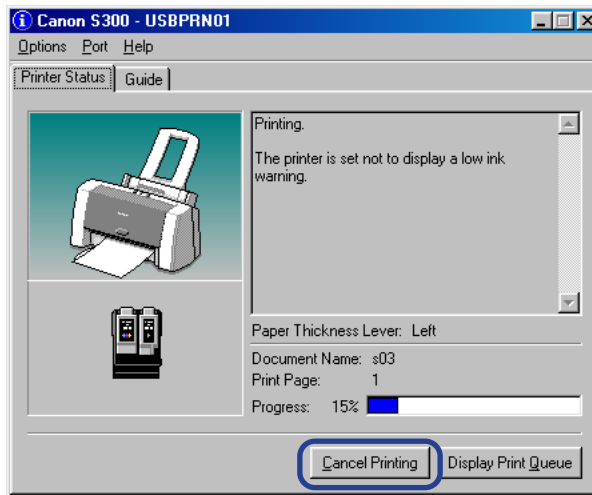

Note ➤ If **Cancel Printing** is grayed out, press the RESUME/CANCEL button on the printer to terminate the print job.

Uninstalling Printer Drivers

Use the Uninstaller to delete the printer driver. The Uninstaller will delete all the files associated with the printer driver.

- 1 Click **Start**, then select **Programs, Canon S300, Uninstall**.
For Windows XP, click **Start**, then **All Programs**, then **Canon S300**, then **Uninstall**.
- 2 Click **Yes** when the confirmation message appears.
- 3 When all the files have been deleted, click **OK**.
The deletion of the printer driver is complete.

If a message prompts you to restart your computer, click **OK**.

Note ➤ In Windows 98 or Windows Me, you can also start the Uninstaller by double-clicking on **Uninstall** in the **Canon S300** folder on the desktop.

Printer Driver Functions (Macintosh)



- Description of Print Settings
- BJ Print Monitor
- Canceling a Print Job
- Using the Printer with a Network
- Uninstalling Printer Drivers

Description of Print Settings

- Page Setup Dialog Box

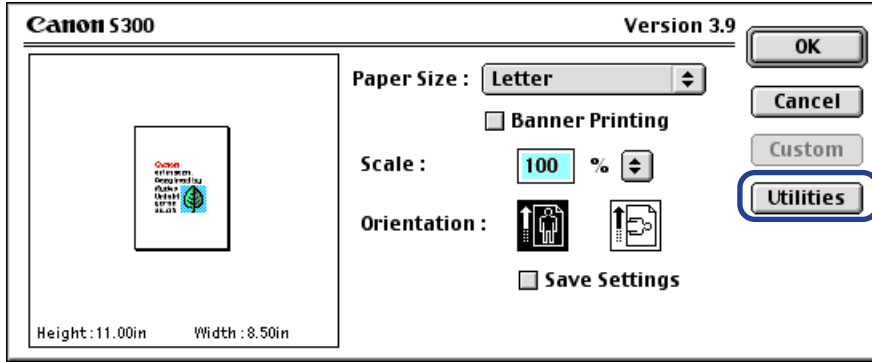

• Printer Utility Dialog Box

- Print Dialog Box

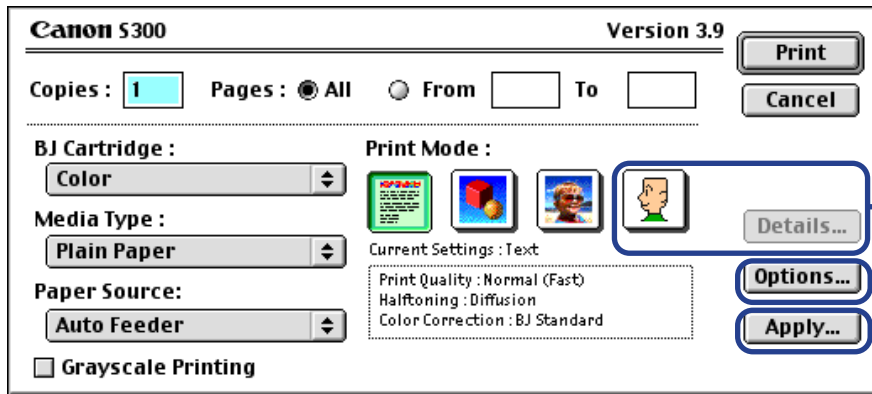

• Detailed Setting Dialog Box

• Options Dialog Box

• Register Settings Dialog Box

Page Setup Dialog Box

The Page Setup dialog box contains settings for the printed page, such as the size of the print media used and the image printed. To open the Page Setup dialog box, select **Page Setup** from the **File** menu in your application program.

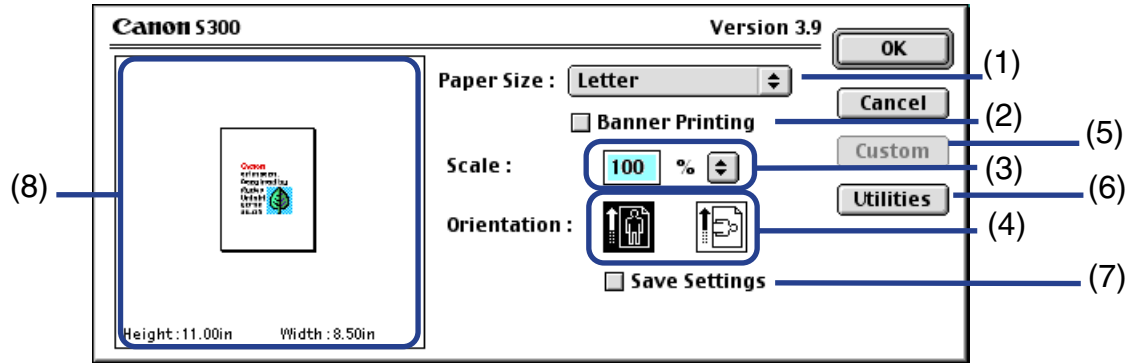

- (1) **Paper Size**
Select the size of the paper for the print job from the drop-down menu. To enter the size manually, select **Custom 1 - Custom 3** and click **Custom**.
- (2) **Banner Printing**
Select this check box when printing on banner paper.
- (3) **Scale**
Specify the scaling percentage to resize the document for printing.
- (4) **Orientation**
Select landscape or portrait printing.

(5) **Custom**

To specify a custom paper size, select **Custom 1** to **Custom 3** from the **Paper Size** pop-up menu (1), then click this button to open the **Custom** dialog box. In the **Custom** dialog box, specify the length and width of the paper.

(6) **Utilities**

Click to open the **Printer Utility** dialog box for maintenance operations such as printhead cleaning, nozzle check pattern printing and changing the print mode.

(7) **Save Settings**

Click to save the settings specified in the **Page Setup** dialog box.

(8) **Preview area**

Shows how the document will print with the selected paper settings.

Printer Utility Dialog Box

The **Printer Utility** dialog box is displayed when you click **Utilities** in the **Page Setup** dialog box.

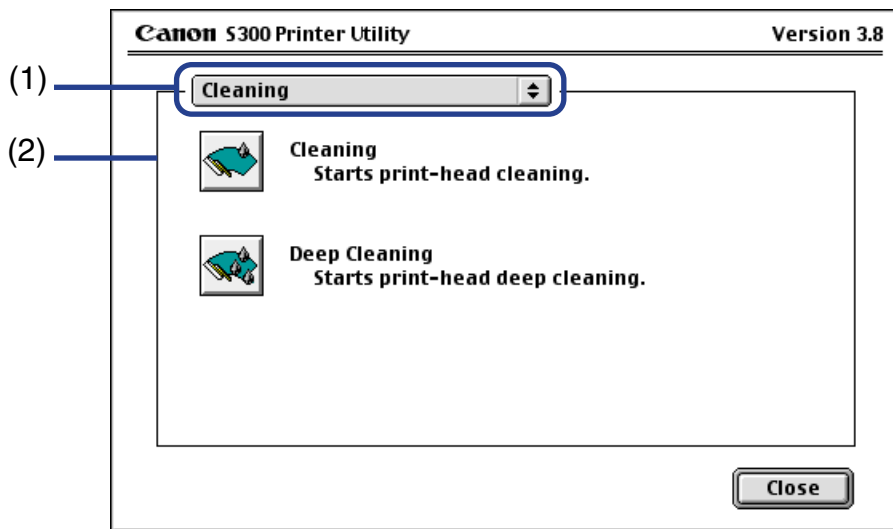

- (1) Select the function you wish to perform.
- (2) Display area showing the various maintenance functions, including cleaning and test pattern printing. Click the icon to start this function. For further details, refer to "Routine Maintenance".

➡ [Printing the Nozzle Check Pattern](#)

Printer Driver Functions (Macintosh)

- ➡ Printhead Cleaning
- ➡ Printhead Deep Cleaning
- ➡ Enabling Low Ink Warning

Note ➤ For information about printhead alignment, refer to the printed *Quick Start Guide*.

Print Dialog Box

The Print dialog box specifies the media type and print settings to be used for your print job. To open the Print dialog box, click **Print** from the **File** menu in your application program.

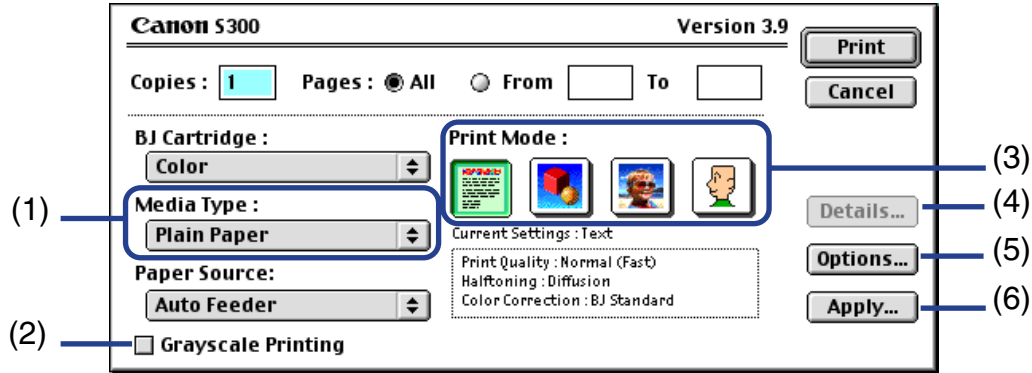

- (1) **Media Type**
Ensure that this setting matches the type of media loaded in the printer.
- (2) **Grayscale Printing**
Click to print a grayscale version of a color document.
- (3) **Print Mode**
Select the icon that most closely resembles your document and required print results.
- (4) **Details**
Manually set the print quality and color settings in the [Detailed Setting Dialog Box](#).
(This option is only available if **Manual** print mode is selected.)

(5) **Options**

Specify the output destination, print order and page layout for the document you are printing.

(6) **Apply**

Save print settings or implement previously saved print settings.

Detailed Setting Dialog Box

To open the Detailed Setting dialog box, click **Manual**  in the **Print** dialog box, then click **Details**.

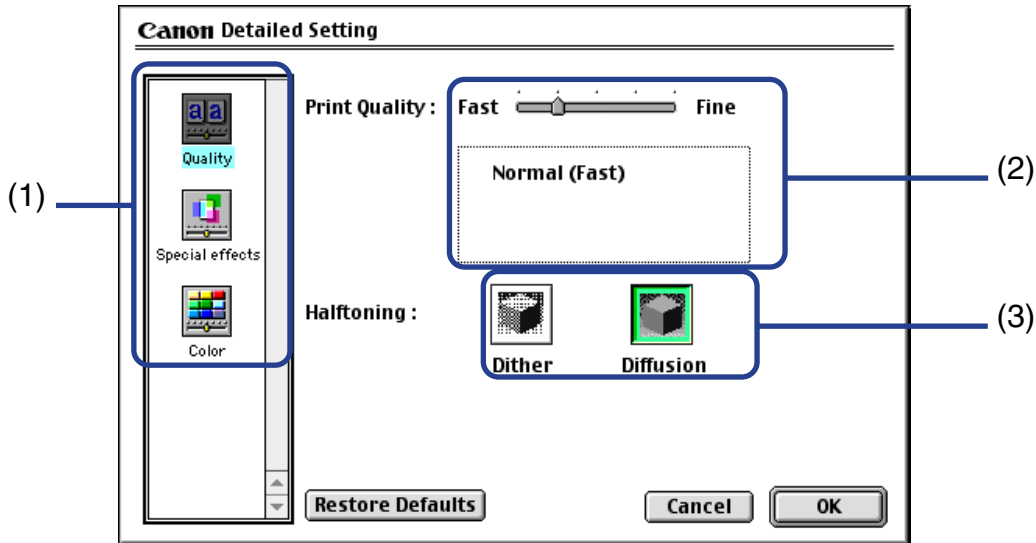

■ Quality Panel

(1) **Panel display icons**

Click these icons to switch between panels in the **Detailed Setting** dialog box.

(2) **Print Quality**

Move the slider to adjust the balance between print quality and speed. Moving the slider to the right enhances print quality, and moving it to the left increases printing speed.

(3) **Halftoning**

Select either **Dither** or **Diffusion** ink dot configurations.

■ Special Effects Panel

To display the Special Effects panel, click the **Special effects** display icon.

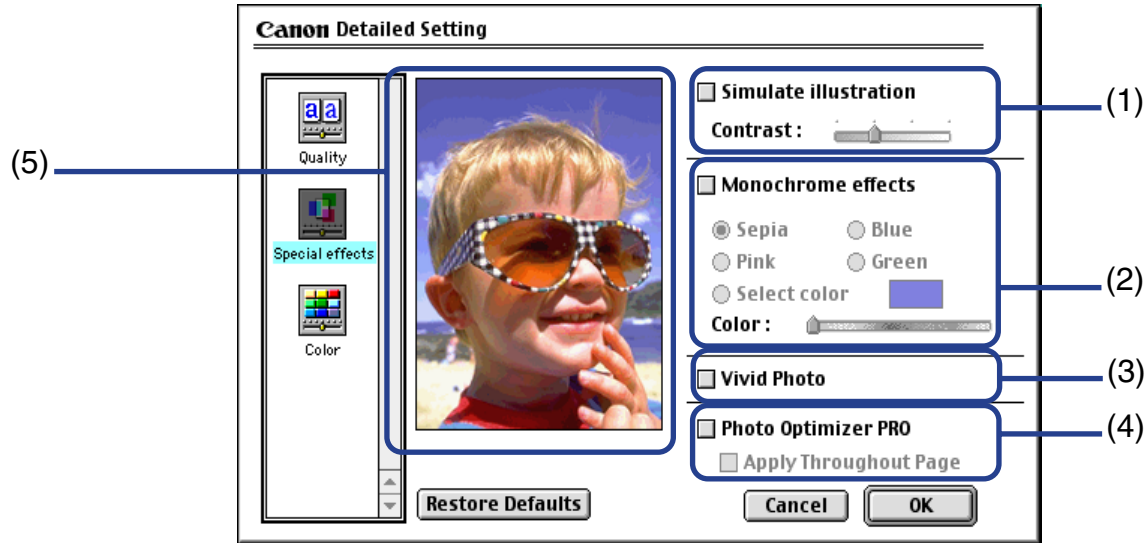

(1) **Simulate illustration**

This function lets you apply graphic effects to a color image without affecting the original document. Select the check box, then adjust the brightness of the image with the **Contrast** slider.

(2) **Monochrome effects**

Prints a color image in a single color. Select the check box, then choose a color, or use a custom color using **Select Color**.

(3) **Vivid Photo**

With this function, you can reproduce breathtaking sceneries in which colors, especially blues and greens, appear even more vibrant. A major feature of this function is its ability to create vivid backgrounds for fields, trees, oceans, and sky, while maintaining the natural skin tones of people who appear in the images.

(4) **Photo Optimizer PRO**

Optimizes the color for images taken from a digital camera or scanner. It is especially effective for images affected by color imbalance and over- or under- exposure. When printing several images on one page, optimization is usually applied to each image according to its requirements. However, if the image data has been manipulated using cut and paste, rotation or other such operations, group optimization of all images on the page is recommended. In such cases, select the **Apply Throughout Page** check box.

(5) **Preview area**

■ Color Panel

To display the Color panel, click the **Color** display icon.

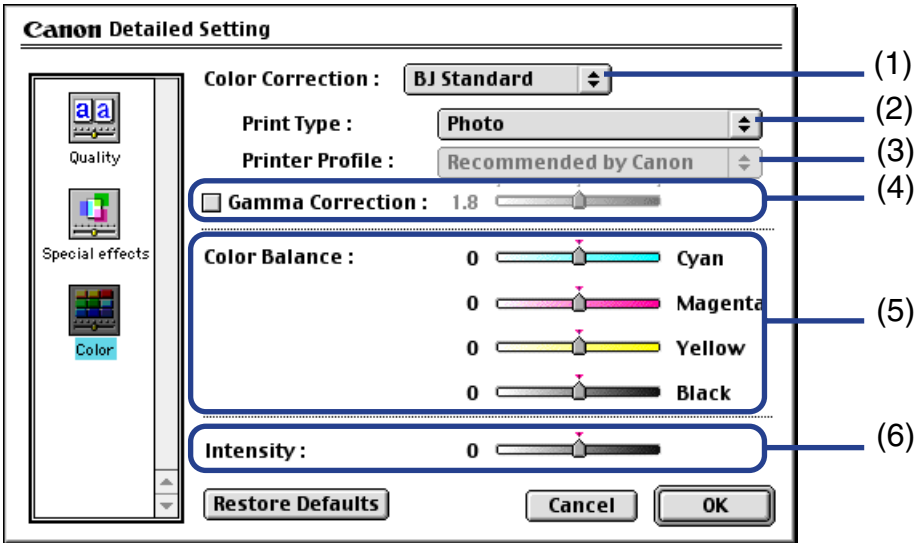

(1) Color Correction

Select a color correction method: **BJ Standard**, **ColorSync** or **None**. **BJ Standard** is usually the optimum color correction method for printing with a BJ printer. When **ColorSync** is selected, you should also specify the **Print Type** and **Printer Profile** settings.

(2) **Print Type**

For printing that emphasizes intermediate colors, select **Photo**. For printing that emphasizes the brightness of primary colors, select **Graphics**. For documents that contain large amounts of a single color, select **Spot Color**.

(3) **Printer Profile**

Select optimized color characteristics (a profile) for the media type and other factors.

(4) **Gamma Correction**

This function adjusts the contrast on colors other than black and white. To adjust the contrast, select the check box, then move the slider. Moving the slider to the right darkens the entire image while increasing contrast in the lighter areas and decreasing contrast in the darker areas.

(5) **Color Balance**

Move the slider for each color to adjust the balance of color intensity. Moving the slider to the right intensifies the color.

(6) **Intensity**

Move the slider to adjust the print intensity. Moving the slider to the right increases the density.

Options Dialog Box

To open the Options dialog box, click **Options** in the **Print** dialog box.

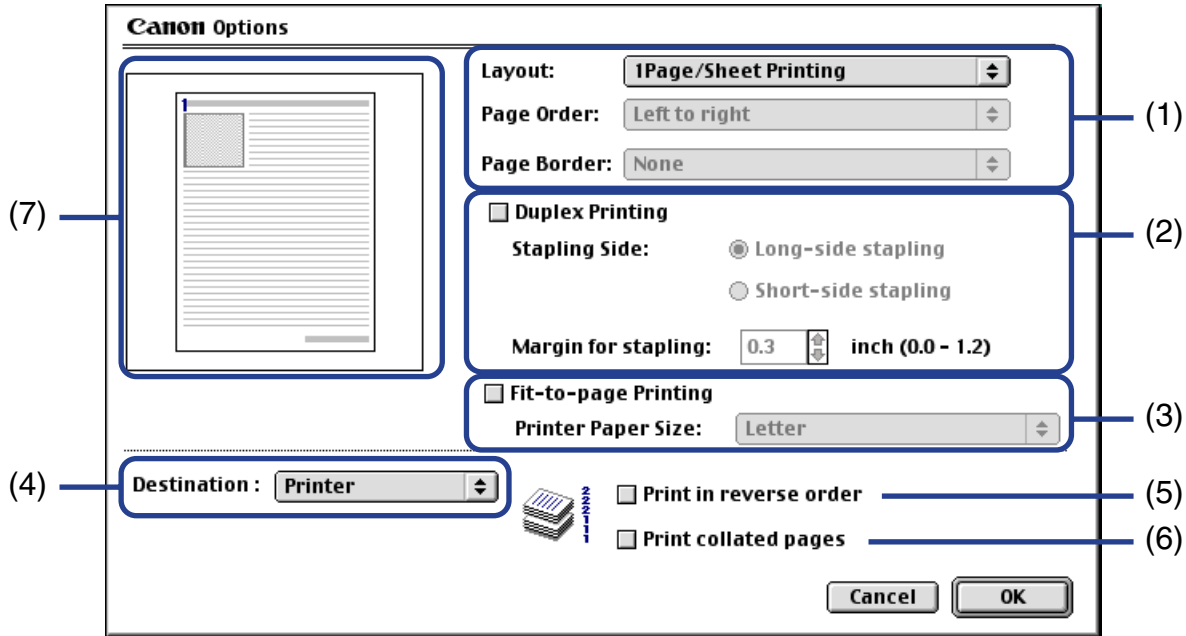

- (1) **Layout**
Use this function to print more than one page on a single sheet of paper. Typically, this is set to **1 Page/Sheet Printing**. If another option is selected, **Page Order** and **Border** can be specified.

2 Page/Sheet Printing, 4 Page/Sheet Printing

Pages are reduced and printed so that two or four pages fit on each printed sheet. You can also select page order and whether to place a border around each page.

Poster (Divided into 4) / (Divided into 9) / (Divided into 16)

These enlarge and split the page across several sheets of paper. The printed sheets can then be assembled to make a large poster. You can also select **Cut/Paste lines** and **Cut/Paste string**. To print only selected pages, click the specific pages on the preview area.

(2) Duplex Printing

The document is printed on both sides of the paper. After printing one side, turn the ejected page over, then print on the other side.

(3) Fit-to-page Printing

Executes scaled printing automatically. When selected, you can specify the **Printer Paper Size**. This fits the document paper size set in the application to the selected paper size.

(4) Destination

Select the print output destination. **Printer** is the usual selection. To check the layout or other image elements before printing, select **Preview**. To save the document as a PICT file, select **PICT File**.

(5) Print in reverse order

Prints the document starting with the last page.

(6) Print collated pages

Prints multiple copies of the document one copy at a time.

(7) Preview area

Register Settings Dialog Box

To open the Register Settings dialog box, click **Apply** in the **Print** dialog box.

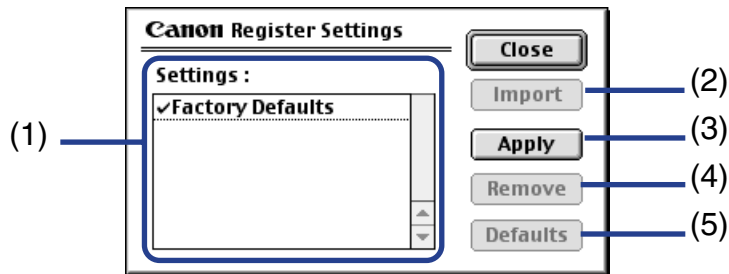

- (1) **Settings**
Displays a list of registered (saved) print settings.
- (2) **Import**
Imports a group of saved printer settings. To use the settings, select the desired settings in the **Settings** list, then click **Import**.
- (3) **Apply**
Saves the settings currently specified in the Print dialog box. After clicking the button, enter the name under which the settings are to be saved.
- (4) **Remove**
Deletes unwanted print settings. To delete unwanted settings, select the settings in **Settings**, then click **Remove**.
- (5) **Defaults**
Causes the selected settings to be used as the default on new documents.

BJ Print Monitor

The BJ Print Monitor displays the progress of print jobs. You can launch the BJ Print Monitor if background printing is enabled in **Chooser**.

■ Opening the BJ Print Monitor

- 1 Click **Chooser** from the Apple menu.
- 2 Set **Backgrounding** to **On**.

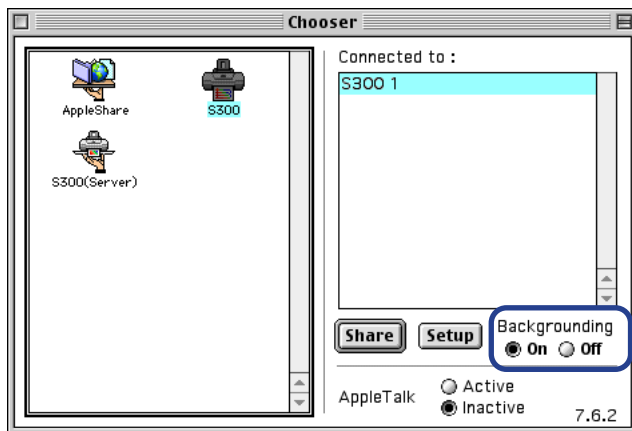

- 3 After starting a print job, select **BJ Print Monitor** in the application menu. The BJ Print Monitor launches.

■ BJ Print Monitor Functions

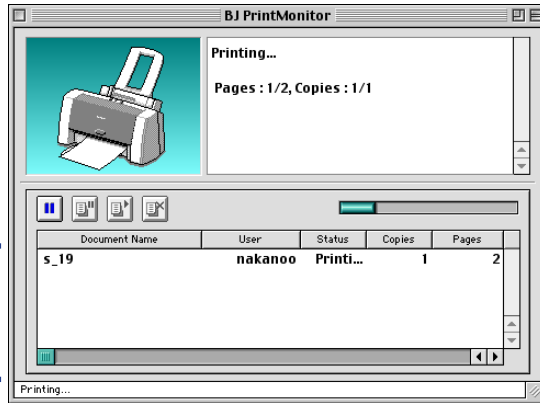

 ... Click to pause printing of the specified document.

 ... Click to resume printing.

 ... Click to cancel printing of the specified document.

Displays the printer status. If an error occurs, instructions on what to do are displayed.

Displays the printer status and ink status with images.

Displays information about the documents queued for printing.

The BJ Print Monitor allows you to change the print order of documents queued for printing. To change the print order, place the mouse pointer over the name of the document, press and hold the mouse button while dragging the document name to the new position, then release. When the print order change includes the current job, the current job stops and the new job immediately starts.



Canceling a Print Job

When the BJ Print Monitor is running, you can use it to cancel or suspend the current print job.

1 Select **BJ Print Monitor** in the application menu.

2 Click the name of the print job you wish to cancel, then click .

The document selected in the Print Monitor is deleted from the print list and the print job is cancelled.

Note ➤ To suspend printing, click the name of the document being printed then click . To resume printing, click .

Using the Printer with a Network

The printer can be used with an Ethernet network environment. Follow the steps described below to connect the printer to the network.

■ Before Setting up the Printer

Install the printer driver on each network computer that will use the printer. For information on installation, refer to the printed *Quick Start Guide*.

■ Printer Setup

To use the printer on a network, first set up the print server, then set up each client machine.

- Print server setup procedure

- 1 Select **Chooser** from the Apple menu.
- 2 Select **Active** in **AppleTalk**.
- 3 Select the **S300** icon, then select the printer name in **Connected to**.

- 4 Click **Share**.
- 5 Confirm that **S300 server** is selected in **Enter new print server name**, then click **Send**.
- 6 Confirm that the new print server name has been added to **Current print servers**, then click **Close**.
- 7 Click the close box to close the Chooser.

- Client setup procedure

- 1 Select **Chooser** from the Apple menu.
- 2 Select **Active** in **AppleTalk**.
- 3 Select the **S300 (Server)** icon, then select the printer server in **Connected to**.
- 4 Click the close box to close the Chooser.

■ Checking Print Status

- Checking print status from the print server
 - To check the status of a print job from the print server, start the BJ Print Monitor by selecting **BJ Print Monitor** from the application menu.
 - To close the BJ Print Monitor, select **Close Status Window** from the **File** menu.
- Checking print status from a client
 - To check the status of a print job from a client, start the BJ Status Monitor by clicking the **BJ Status Monitor** icon in the **BJ Extras** folder.
 - To close the BJ Status Monitor, select **Quit** from the **File** menu.
- The BJ Print Monitor and BJ Status Monitor
 - The BJ Print Monitor and the BJ Status Monitor both display a list of information concerning documents queued for printing. This information includes the document name, number of pages, number of copies and the time the print job was accepted. The total number of queued documents is also displayed.
 - The BJ Print Monitor allows you to change the print order of the queued documents.

➡ [BJ Print Monitor Functions](#)

➡ [BJ Status Monitor Functions](#)

■ BJ Status Monitor Functions

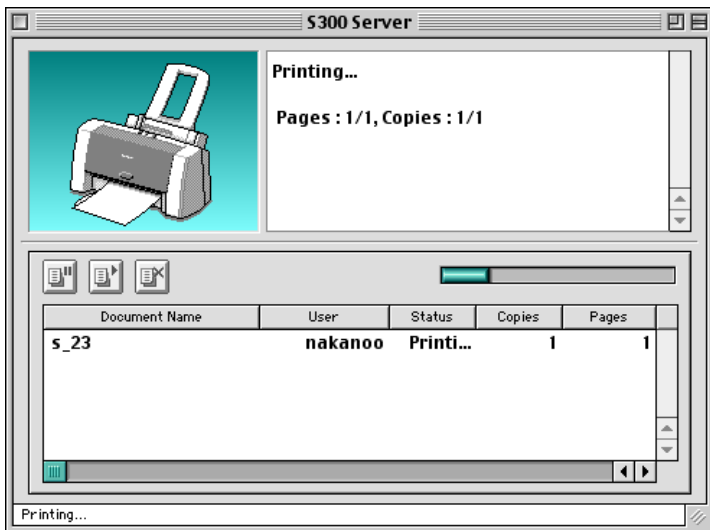

Click to pause printing of the specified document.



Click to resume printing.



Click to cancel printing of the specified document.

Note



- You can determine the owner of a computer by selecting the **File Sharing** control panel and checking the **Owner Name** item.
- If you are using two or more printer servers, you can switch between the BJ Status Monitor displays. Select **Print Server** from the **File** menu, then select the desired print server and click **OK**.

Uninstalling Printer Drivers

When a printer driver is no longer needed, use the Installer to delete all program files associated with it at the same time.

Before proceeding, ensure that you save any unsaved files in any currently running applications.

- 1 Load the *Setup Software & User's Guide CD-ROM*.
- 2 Double-click the **Printer Driver** folder.
- 3 Double-click the **Installer** icon.
- 4 When the Software License Agreement is displayed, click **Accept**.
- 5 Select **Uninstall** from the pop-up menu, then click **Uninstall**.

Note

- ▶ If a warning message appears indicating that other applications are running:
 - Click **Cancel** and save the document(s) if there are any unsaved documents open in the other applications.
 - Click **Continue** to continue the uninstall operation.
- 6 After the uninstall is complete, a message will appear prompting you to restart your computer. Click **Restart**.

Routine Maintenance

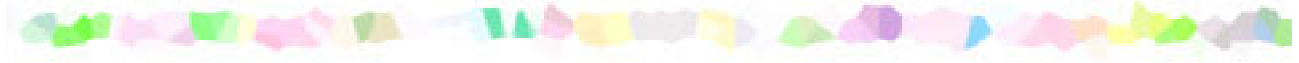

- When to Replace Ink Tank and Maintain Printhead
- Replacing an Ink Tank
- Printing the Nozzle Check Pattern
- Printhead Cleaning
- Printhead Deep Cleaning
- Enabling Low Ink Warning
- Transporting the Printer

When to Replace Ink Tank and Maintain Printhead

When printing becomes faint or colors are incorrect, check if the printhead nozzles are clogged and clean them first. Follow the procedures below and replace an ink tank if necessary.

- ➡ Printing the Nozzle Check Pattern
 - ↓ If the print quality is poor
- ➡ Printhead Cleaning
 - ↓ If the problem remains
- ➡ Printhead Deep Cleaning
 - ↓ The problem continues
- ➡ Replacing an Ink Tank

If ink tank replacement does not resolve the problem, the printhead may be worn out. Contact the Customer Care Center.

Note ➤ If low ink warning is enabled, you will be alerted when a tank is low on ink.

- ➡ Enabling Low Ink Warning

Replacing an Ink Tank

When replacing an ink tank, check the model number very carefully. The printer will not print properly if the wrong ink tank is used, or if an ink tank is installed in the incorrect position.

- Black: BCI-24 Black
- Color: BCI-24 Color

Note ► Damage caused by using a refilled cartridge is not covered by the Canon warranty. Canon recommends using only original Canon ink tanks to ensure the best quality.

- 1 Ensure that the printer is on, then open the front cover.
The printhead holder moves to the left.

2 Remove the empty ink tank.

Pull the tab on the ink tank toward you to release.

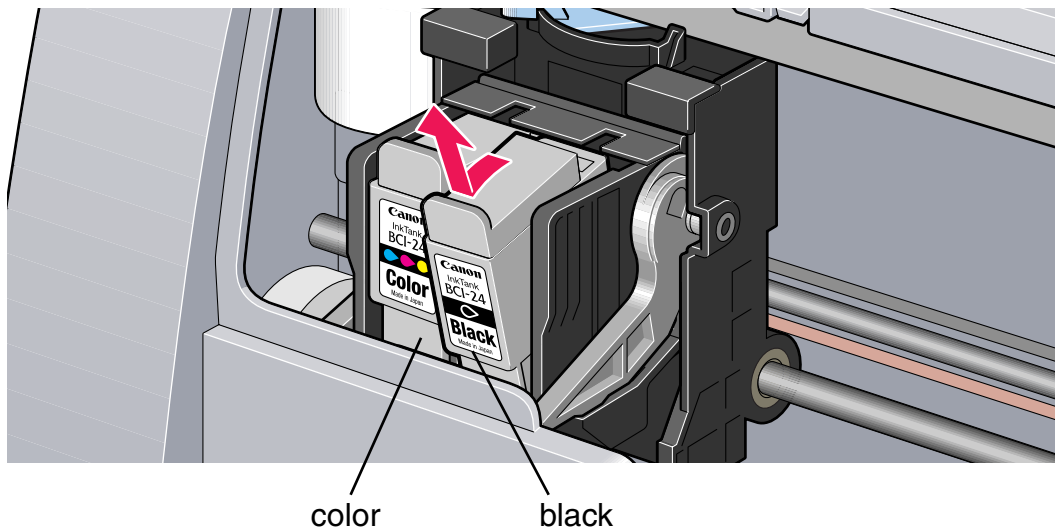

Lift the ink tank from its slot.

Do not touch the lock lever; remove only the ink tank.

Important ►

- To avoid spilling ink, do not touch the bottom of an ink tank once you have removed the protective cap.
- Discard empty ink tanks according to the local laws and regulations regarding disposal of consumables.

- 3 Unpack the new ink tank and remove the orange protective cap.

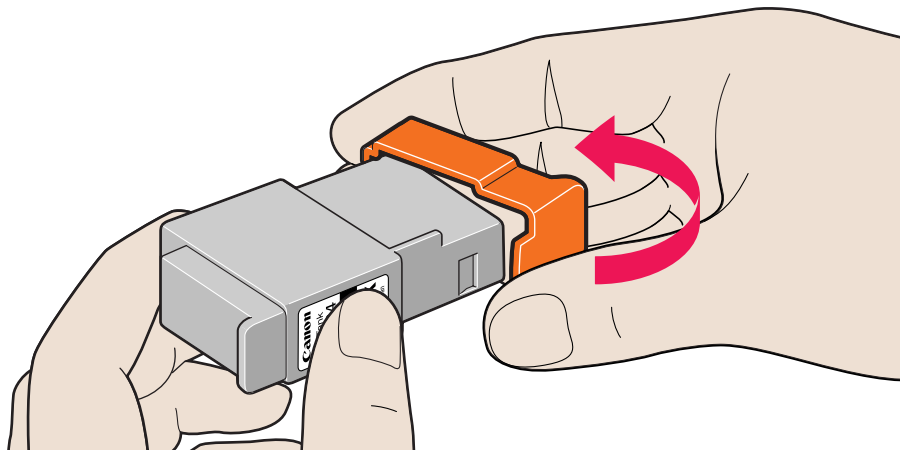

Important ▶

- Do not re-attach the protective cap once you have removed it.
- To avoid spilling ink, do not touch the bottom of an ink tank once you have removed the protective cap.

- 4 Insert the ink tank into the empty slot.

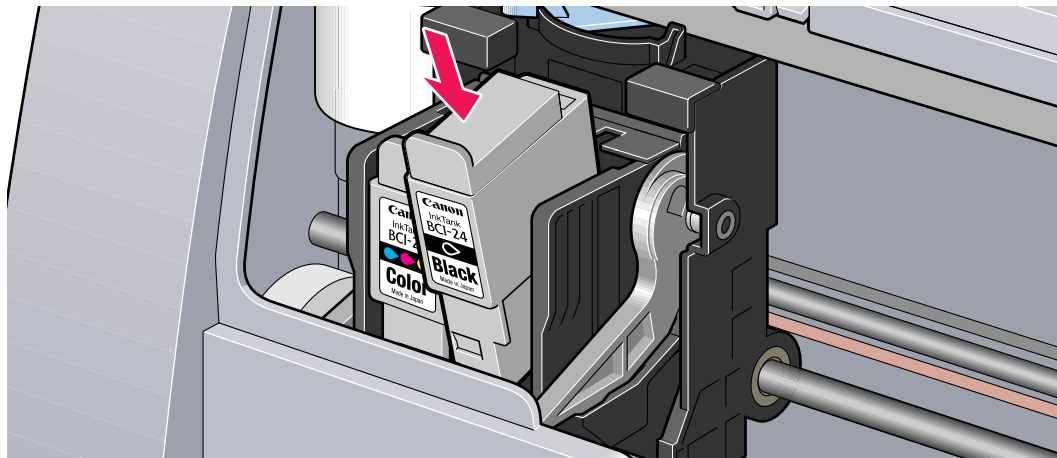

- 5 Press on the tab until the ink tank snaps firmly into place.

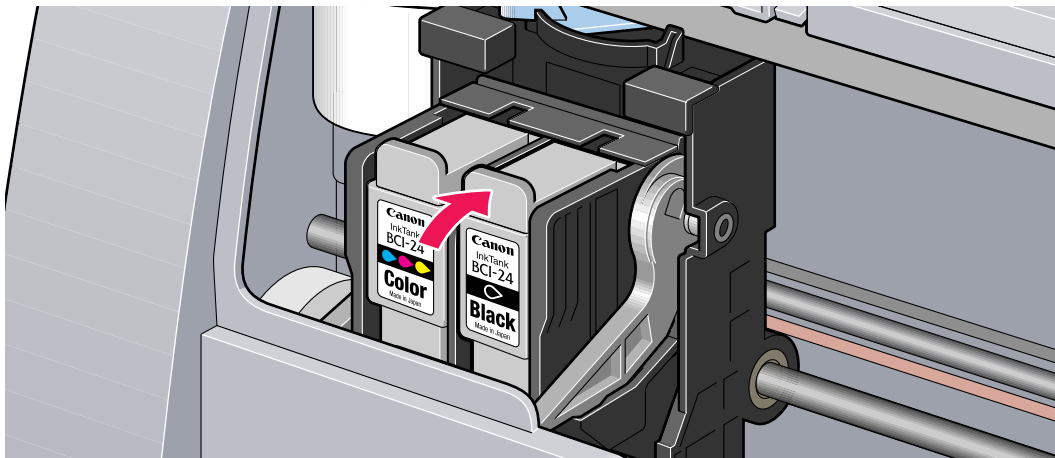

- 6 Close the front cover.

The printhead holder moves to the right. The ink tank installation process is now complete.

Note

- ▶ To maintain optimal print quality, use an ink tank within six months of first use.
- ▶ Once an ink tank has been used, do not remove it from the printer and leave it in the open. Leaving an ink tank in the open will cause ink to dry, and the printer may not function properly when the ink tank is reinstalled.

Printing the Nozzle Check Pattern

Print the nozzle check pattern to determine whether the ink ejects normally from the printhead nozzles, and to verify printhead alignment. Use this function when printed results are blurred or the color is incorrect.

Nozzle check pattern printing can be executed from the Windows and Macintosh printer drivers, or from the printer itself.

■ Printing the Nozzle Check Pattern from the Printer Drivers

Windows

- 1 With the printer on, load a sheet of plain letter-size paper in the printer.
- 2 Open the Printer Properties dialog box.
 - ➡ [Opening the Printer Properties Dialog Box](#)
- 3 Click the **Maintenance** tab, then click the **Nozzle Check** icon.
- 4 When the confirmation message is displayed, click **OK**.
 - ➡ [Examining the Nozzle Check Pattern](#)

Macintosh

1 With the printer on, load a sheet of plain letter-size paper in the printer.

2 Open the Page Setup dialog box.

The Page Setup dialog box can normally be opened by selecting **Page Setup** in the **File** menu.

3 Click **Utilities** to open the Printer Utilities dialog box.

4 Select **Test Print** from the drop-down menu, then click the **Nozzle Check** icon.

5 When the confirmation message is displayed, click **OK**.

➡ [Examining the Nozzle Check Pattern](#)

■ Printing the Nozzle Check Pattern through the Printer

- 1 With the printer on, load a sheet of plain letter-size paper in the printer.
- 2 Press and hold the RESUME/CANCEL button until the POWER lamp flashes twice.

➡ [Examining the Nozzle Check Pattern](#)

■ Examining the Nozzle Check Pattern

The nozzle check pattern should appear as follows when ink is discharging properly. Examine the nozzle check pattern output by the printer.

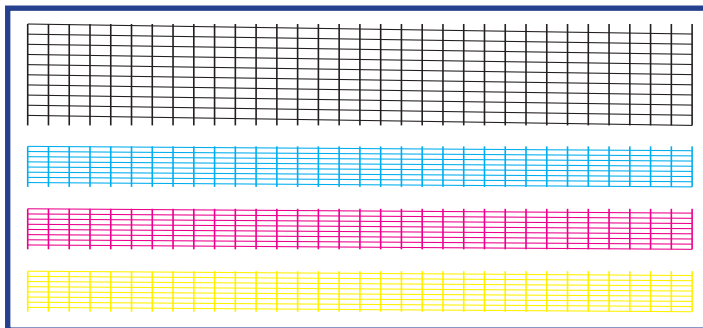

Lines missing here indicate the printhead requires cleaning.

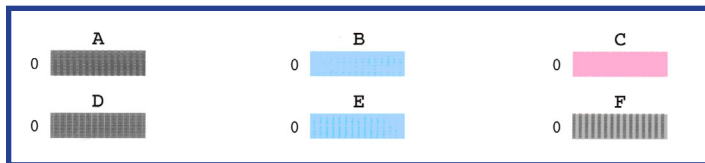

Unevenness in these patterns indicates the printhead requires alignment.

Printhead Cleaning

Clean the printhead if you suspect that the nozzles might be clogged. Head cleaning can be performed either from the printer drivers or from the printer itself.

Note ➤ Cleaning the printhead consumes ink, so perform printhead cleaning only when necessary.

■ Cleaning the Printhead from the Printer Drivers

Windows

- 1 Ensure that the printer is on.
- 2 Open the Printer Properties dialog box.
 - ➡ [Opening the Printer Properties Dialog Box](#)
- 3 Click the **Maintenance** tab, then click the **Cleaning** icon.

- 4 Select the ink nozzles to be cleaned, then click **Execute**.

All colors:	All nozzles
Black:	Black ink nozzles
Color:	Color ink nozzles

- 5 When a confirmation message is displayed, click **OK**.

Macintosh

- 1 Ensure that the printer is on.
- 2 Open the Page Setup dialog box.
The Page Setup dialog box can normally be opened by selecting **Page Setup** from the **File** menu.
- 3 Click **Utilities** to open the Printer Utility dialog box.
- 4 Select **Cleaning** from the drop-down menu, then click the **Cleaning** icon.

- 5 Select the ink nozzles to be cleaned, then click **OK**.

All colors:	All nozzles
Black:	Black ink nozzles
Color:	Color ink nozzles

■ Cleaning the Printhead from the Printer

This operation cleans all nozzles, both black and color. Because this method also resets the printer, any print data stored in the printer is lost.

- 1 Ensure that the printer is on.
- 2 Press and hold the RESUME/CANCEL button until the POWER lamp flashes once.

The POWER lamp will start flashing as printhead cleaning begins. Do not perform any other operations until printhead cleaning is complete. This takes about 50 seconds. After printhead cleaning finishes, print the nozzle check pattern to verify that the printhead nozzles are clean.

 [Printing the Nozzle Check Pattern](#)

Printhead Deep Cleaning

If print quality does not improve by standard printhead cleaning, try deep cleaning, which is a more powerful process. Perform printhead deep cleaning from the printer driver.

Note ➤ Printhead deep cleaning consumes ink, so perform this procedure only when necessary.

Windows

- 1 Ensure that the printer is on.
- 2 Open the Printer Properties dialog box.
➡ [Opening the Printer Properties Dialog Box](#)
- 3 Click the **Maintenance** tab, then click the **Deep Cleaning** icon.
- 4 When the confirmation message is displayed, click **OK**.

Macintosh

- 1 Ensure that the printer is on.
- 2 Open the Page Setup dialog box.

The Page Setup dialog box can normally be opened by selecting **Page Setup** from the **File** menu.
- 3 Click **Utilities** to open the Printer Utility dialog box.
- 4 Select **Cleaning** from the drop-down menu, then click the **Deep Cleaning** icon.
- 5 Click **OK**.

The POWER lamp will start flashing as printhead deep cleaning begins. Do not perform any other operations until printhead cleaning is complete. This can take up to two minutes. The POWER lamp stops flashing when printhead cleaning is complete.

After printhead deep cleaning finishes, print the nozzle check pattern to verify that the printhead is clean. If not, perform printhead deep cleaning again. If the printhead is still not clean after the second deep cleaning, the printhead may be worn out. In this event, contact the Customer Care Center.

 [Printing the Nozzle Check Pattern](#)

Enabling Low Ink Warning

When enabled, the low ink warning notifies you during printing if ink runs low. This feature can be enabled or disabled from the printer driver.

■ How Low Ink Warning Works

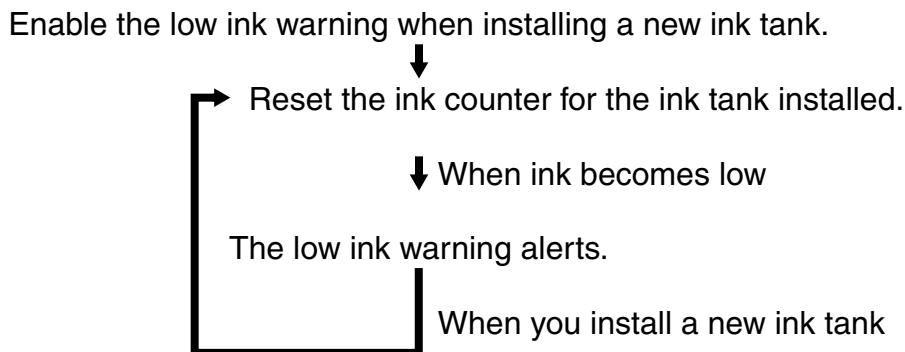

When you reset the ink counter, the counter will assume that the ink tank is full, regardless of how much ink actually remains. Resetting the counter on a *new* ink tank is the only way to match the counter value with the actual ink volume, so you should only enable the low ink warning and reset the ink counter when installing a new ink tank.

➡ How to Display Accurate Low Ink Warning

■ Low Ink Warning Display

The '!' indicates that the ink is running low.

The color ink tank is running low.

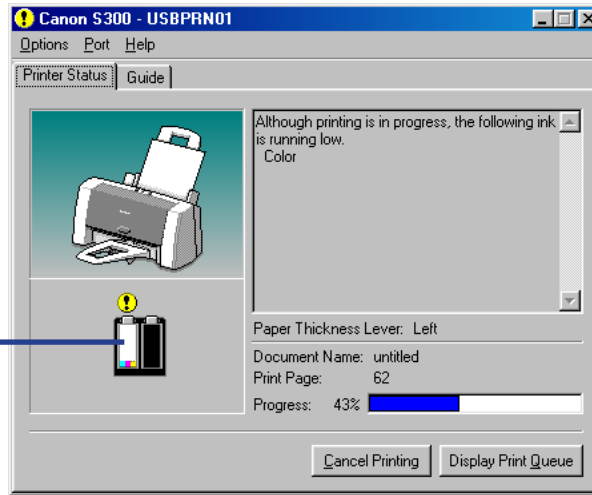

BJ Status Monitor (Windows)

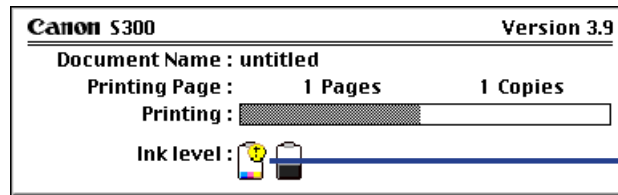

BJ Status Dialog (Macintosh)

The color ink tank is running low.

Macintosh

Note ➤ When background printing is enabled, the low ink warning displays on the BJ Print Monitor (Macintosh).

➡ BJ Print Monitor

■ How to Display Accurate Low Ink Warning

- Reset the ink counter every time you install a new ink tank.
The ink counter is only accurate when synchronized with the actual ink level. To synchronize the counter with the actual ink level, the ink counter must be set *only* immediately after installing a new ink tank.
- Do not reset the ink counter for an ink tank that is in use.
This would disrupt synchronization between the counter and the actual ink level.

Note ➤

- Ink counters for black and color ink tanks work independently of each other. However, both start counting at the time you enable the low ink warning. If you did not reset the counter for a specific ink tank when it was first installed, the low ink warning may not function correctly for that tank. Do not reset the ink counter until you install a new ink tank. Also note that the counter for each ink tank must be started separately.
- Refer to "[Low Ink Warning Displays Ink Tank with '?'](#)" if the ink tanks and counters are not synchronized.

■ Setting Low Ink Warning

Note ➤ Reset the ink counter every time you install a new ink tank. Otherwise, the ink level will not display correctly.

- Enabling Low Ink Warning

Windows

- 1 Ensure that the printer is on, then open the Printer Properties dialog box.
➡ [Opening the Printer Properties Dialog Box](#)
- 2 Click the **Maintenance** tab, then click the **Low Ink Warning Setting** icon.
- 3 Click **Display low ink warning**, then click **Send**.

Macintosh

- 1 Ensure that the printer is on, then open the Page Setup dialog box.
The Page Setup dialog box can normally be opened by clicking **Page Setup** from the **File** menu.
- 2 Click **Utilities** to open the **Printer Utility** dialog box.

- 3 Select **Low Ink Warning** from the drop-down menu, then click the **Remaining ink level setting** icon.
- 4 Click **Display low ink warning**, then click **Send**.

- Resetting Ink Counter

Note ➤ Do not reset the ink counter for an ink tank that is already in use.

Windows

- 1 Ensure that the printer is on and open the Printer Properties dialog box.
➡ [Opening the Printer Properties Dialog Box](#)
- 2 Click the **Maintenance** tab, then click the **Ink Counter Reset** icon.
- 3 Select the ink tank just installed (black or color), then click **Execute**.

Macintosh

- 1 Ensure that the printer is on, then open the Page Setup dialog box.
The Page Setup dialog box is normally opened by selecting **Page Setup** from the **File** menu.

- 2 Click **Utilities** to open the **Printer Utility** dialog box.
- 3 Select **Remaining ink level setting** from the drop-down menu, then click **Ink Counter Reset**.
- 4 Select the ink tank just installed (black or color) and click **Execute**.

Transporting the Printer

Pack the printer carefully in its original packing materials.

If you do not have the original packing materials, pack the printer carefully and thoroughly in protective material and place it inside a sturdy box.

- 1 Turn the printer off.
- 2 After making sure that the POWER lamp is off, unplug the printer.

Important ► To protect the printer from damage, do not unplug the printer while the POWER lamp is lit or flashing.

- 3** Remove the paper rest and the paper output tray.

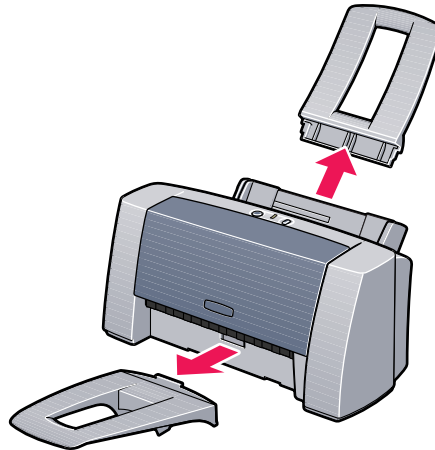

- 4** Disconnect the printer cable from the computer and from the printer, then disconnect the power cord from the printer.

- 5 Secure the printer with adhesive tape as shown, then pack it in a plastic bag.

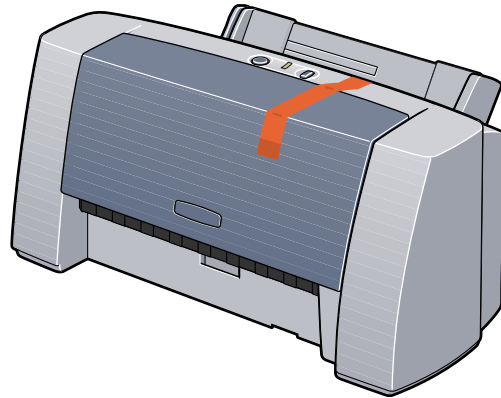

- 6 Attach protective material to both sides of the printer when packing the printer.

Clearly label the box as "Fragile" if using a transport company.

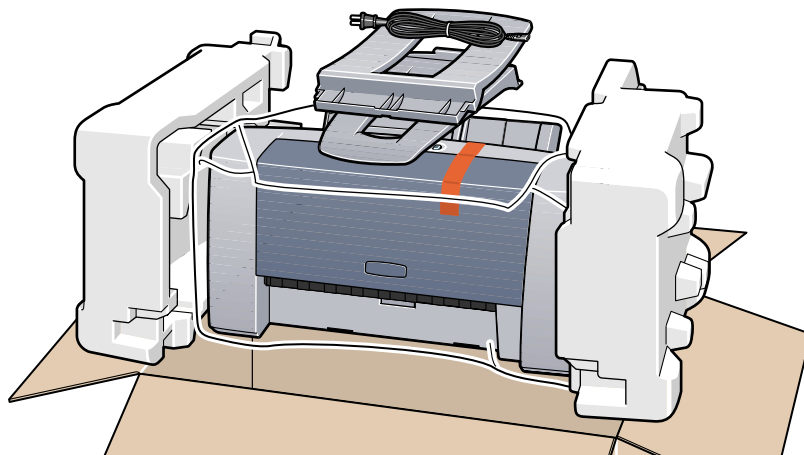

Printing Media

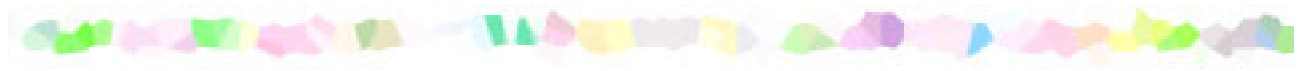

- Compatible Media Types
- Envelopes
- High Resolution Paper HR-101N
- Glossy Photo Paper GP-301N/GP-301
- High Gloss Photo Film HG-201
- Glossy Photo Cards FM-101
- Photo Paper Pro PR-101
- Photo Paper Pro PC-101S
- Transparencies CF-102
- T-Shirt Transfers TR-201
- Banner Paper

Compatible Media Types

You can use the following types of paper and other media:

■ Size

- Standard paper: From A5 size (5.83 x 8.27 in.) to legal size (8.5 x 14.0 in.)
- Non-standard paper: From 3.54 x 4.72 in. to 8.5 x 23.0 in.
- Others: Envelopes (US Com. #10 and European DL)

Important ► Do not use the following types of paper. Using such paper will not only produce unsatisfactory results, but can also cause the printer to jam or malfunction.

- Folded, curled or wrinkled paper
- Wet paper
- Paper that is too thin (less than 17 lb.)
- Paper that is too thick (more than 28 lb.)
- Picture postcards
- Postcards with an affixed photo or sticker
- Envelopes with a double flap
- Sealed envelopes
- Envelopes with an embossed or treated surface
- Paper with holes (such as loose-leaf paper)

■ Weight

17 to 28 lb.

Do not use paper heavier than this as it could jam in the printer.

■ Types

The following types of media can be used.

For more information about the media and the printing methods, refer to the specific sections.

Plain paper: Refer to the printed *Quick Start Guide*.

- ➡ Envelopes
- ➡ High Resolution Paper HR-101N
- ➡ Glossy Photo Paper GP-301N/GP-301
- ➡ High Gloss Photo Film HG-201
- ➡ Glossy Photo Cards FM-101
- ➡ Photo Paper Pro PR-101
- ➡ Photo Paper Pro PC-101S
- ➡ Transparencies CF-102
- ➡ T-Shirt Transfers TR-201
- ➡ Banner Paper

Envelopes

Use US Com. #10 or European DL size envelopes.

■ Preparation for Printing

- 1 Press down on all four corners and edges of the envelopes to flatten them as shown below.
- 2 If the envelopes are curled, hold the opposite corners and gently bend them in the opposite direction.

Ensure that the flap of the envelope is perfectly straight.

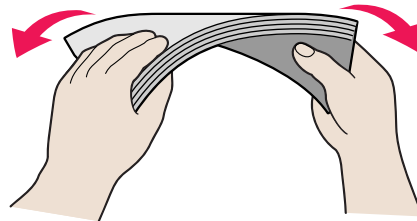
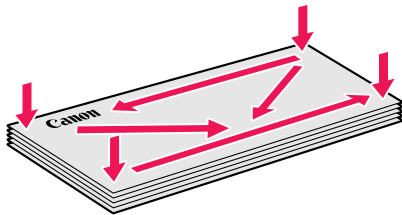

- 3 If the leading edge of an envelope is puffed up or curled, use a pen to press the envelope flat and sharpen the crease.

Press the envelope completely flat, working from the middle to the edge.

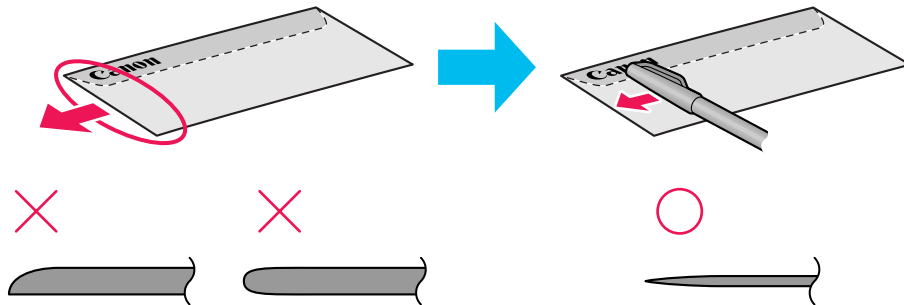

* The above illustrations show a side view of the leading edge of the envelope.

The envelopes may jam in the printer if they are not completely flat and the edges are not aligned.

Ensure that no curl or puff exceeds 0.1 in.

■ Unsuitable Envelopes

- Envelopes with an embossed or treated surface
- Envelopes with a double flap or pressure seals

■ Loading

- Place envelopes lengthwise with the flap to the left and the address side facing upward.
- Set the paper thickness lever to the right.
- Up to 10 envelopes can be loaded at once.

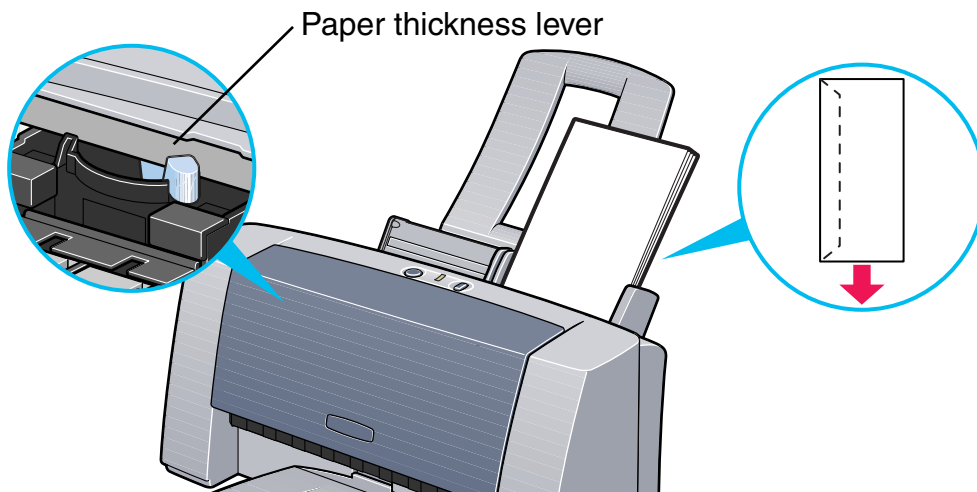

Note

- If the envelopes still do not feed properly even after removing curl, clean the paper feed roller.
- 1 Ensure that the printer is on, and that no paper is loaded in the printer.
 - 2 Press and hold the RESUME/CANCEL button, then release as the POWER lamp flashes three times.
The paper roller will rotate ten times as it cleans.
Repeat this three times.

- 3 Load a sheet of plain letter-size paper in the printer.
- 4 Press and hold the RESUME/CANCEL button, then release as the POWER lamp flashes three times to feed the sheet.
Repeat this three times.

If the printer still does not feed the envelopes through even after cleaning, repeat Step 4 again.

■ Printer Driver Settings

- **Media Type:** Envelope
- **Page Size:** Select either **#10 Env.** or **DL Env.** according to the envelope size you are using
- **Orientation:** Landscape

■ Handling of Printed Output

Remove each envelope as it is printed.

■ Printable Area

➡ Printing Area

High Resolution Paper HR-101N

This type of paper provides better color reproduction than plain paper. It is suitable for printing business documents that feature graphics, and for photographs.

■ Loading

- Load the paper with the whiter side facing up.
- Set the paper thickness lever to the left.
- Do not load paper higher than the limit mark. A maximum of 80 sheets can be loaded.

Paper thickness lever

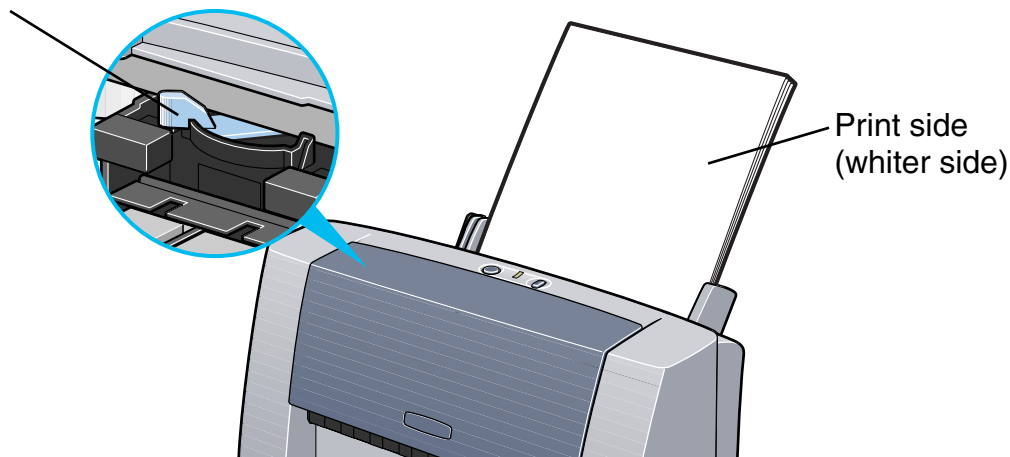

■ Printer Driver Settings

- **Media Type:** High Resolution Paper
- **Page Size:** Ensure that the setting matches the size set in the application.

■ Handling of Printed Output

Do not allow more than 50 sheets to stack in the paper output tray. If the output paper is curled, it may prevent the next sheet from being ejected. In this case, or if the ink takes a long time to dry, remove each sheet as soon as it is printed.

■ Printable Area

 Printing Area

Glossy Photo Paper GP-301N/GP-301

This media is thicker than High Resolution Paper, with a glossy printing surface to produce printouts close to photograph quality.

■ Loading

- Load the paper with the whiter side facing up.
- Set the paper thickness lever to the left.
- A maximum of 10 sheets can be loaded at once.
- When printing on Glossy Photo Paper GP-301, do not use a loading support sheet.

Paper thickness lever

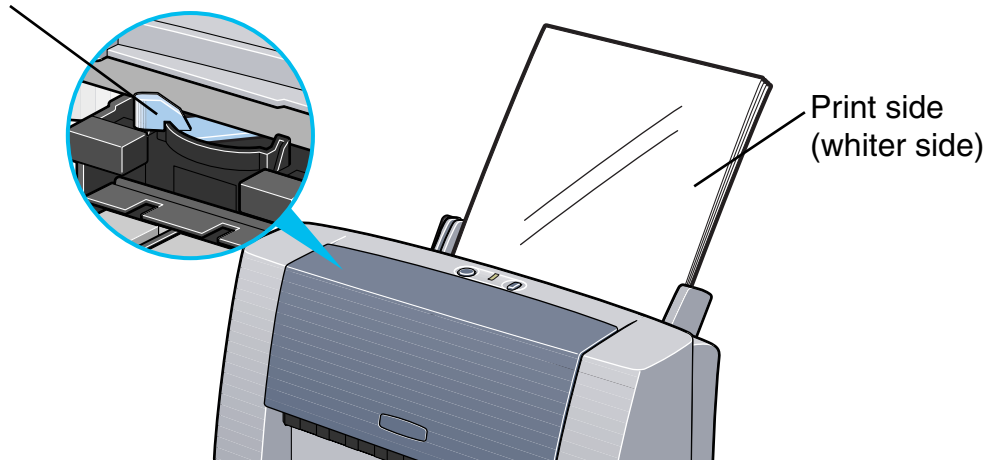

■ Printer Driver Settings

- **Media Type:** Glossy Photo Paper
- **Page Size:** Ensure that the setting matches the size set in the application.

■ Handling of Printed Output

- Do not stack more than 10 sheets in the paper output tray.
- Do not touch the printed surface until the ink dries (approx. two minutes).

■ Printable Area

 Printing Area

High Gloss Photo Film HG-201

This film has an extremely glossy surface, ideal for printing photographs with outstanding results.

■ Loading

- Load only one sheet at a time.
- Load the film with the cut corner at the upper right.
- If the film is curled, flatten it by curling in the opposite direction.
- Set the paper thickness lever to the left.

Paper thickness lever

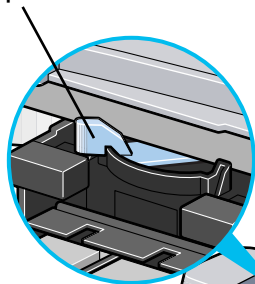

Cut corner

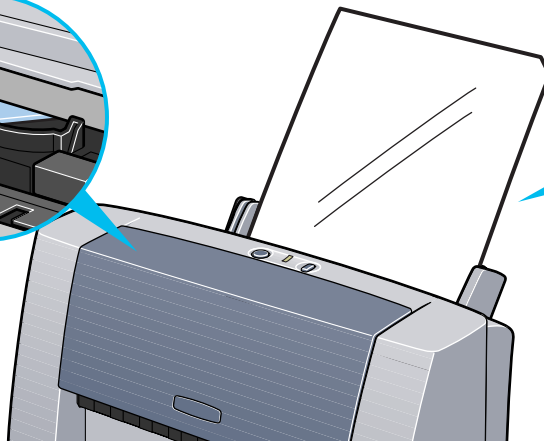
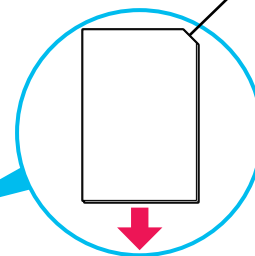

■ Printer Driver Settings

- **Media Type:** High Gloss Photo Film
- **Page Size:** Ensure that the setting matches the size set in the application.

■ Handling of Printed Output

- Remove each sheet as soon as it is printed.
- Do not touch the printed surface until the ink dries.

■ Printable Area

 Printing Area

Glossy Photo Cards FM-101

Made of the same material as Glossy Photo Paper GP-301, this photo-size paper is intended for printing images that cover the entire surface of the card, without a white border. To take full advantage of FM-101, make the images slightly larger than the area indicated by the perforations.

■ Loading

- Load the paper with the glossy side facing up.
- Set the paper thickness lever to the left.
- A maximum of 20 sheets can be loaded at once.
- Do not use the loading support sheet provided with the package.

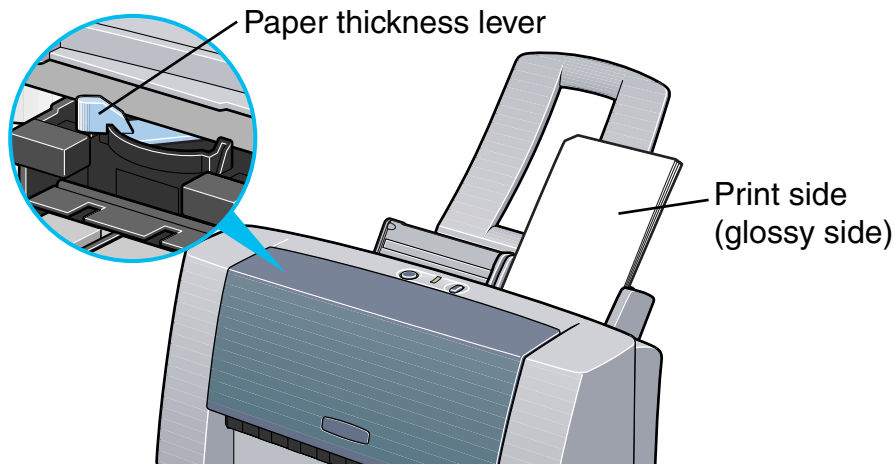

■ Printer Driver Settings

- **Media Type:** Glossy Photo Cards
- **Page Size:** Canon 4 x 6 in.

■ Handling of Printed Output

- Do not allow more than 20 sheets to stack in the paper output tray.
- Do not touch the printed surface until the ink dries (approx. two minutes).

■ Printable Area

 Printing Area

Photo Paper Pro PR-101

This is thick paper with a treated surface that enhances gloss and provides superior color reproduction. It is ideal for printing high quality photographs.

■ Loading

- Load only one sheet at a time.
- Load the paper with the glossier side facing up.
- Set the paper thickness lever to the left.

Paper thickness lever

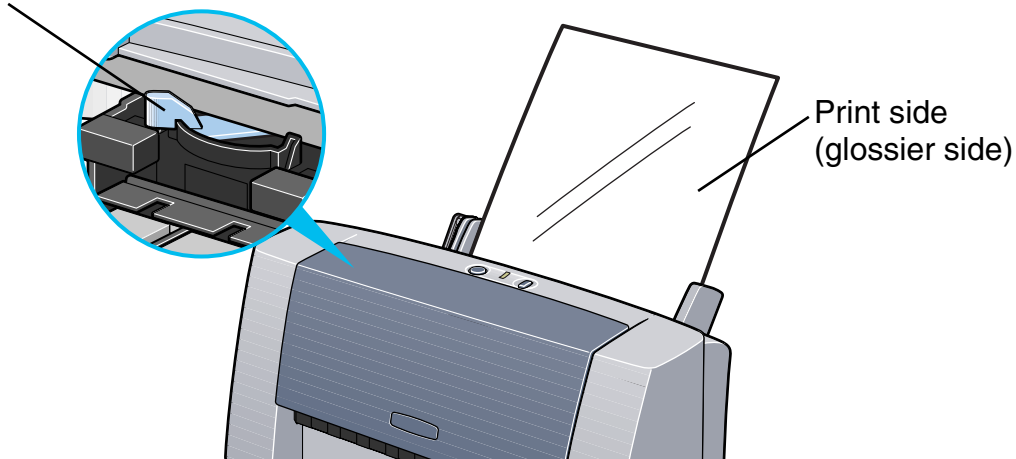

■ Printer Driver Settings

- **MediaType:** Photo Paper Pro
- **Page Size:** Ensure that the setting matches the size set in the application.

■ Handling of Printed Output

- Remove each sheet as soon as it is printed.
- Do not touch the printed surface until the ink dries (approx. 30 minutes). Colors in dark images may appear indistinct at first, but become clearer after about 30 minutes.
- Images may smudge if you place them in an album before the ink is completely dry. It is recommended that you allow the ink to dry for 24 hours.
- Do not attempt to dry the ink with a hair dryer or by exposing printed sheets to direct sunlight.

■ Storing Printed Output

- Do not store or display printouts in hot, damp or humid conditions. Never expose them to heat or direct sunlight.
- Store printouts in photo albums, photo frames or presentation binders to protect them from direct exposure to air or sunlight.
- Do not mount printouts in an adhesive-type album, as you may not be able to remove them.
- Be aware that some types of clear plastic folders and albums may cause the edges of the paper to turn yellow.

■ Printable Area



Photo Paper Pro PC-101S

Made of the same material as Photo Paper Pro PR-101, this photo-size paper is intended for printing images that cover the entire surface of the card, without a white border. To take full advantage of PC-101S, make the images slightly larger than the area indicated by the perforations. This paper is ideal for printing high quality photographs.

■ Loading

- Load the paper with the glossy side facing up.
- Set the paper thickness lever to the left.
- A maximum of 20 sheets can be loaded at once.

Paper thickness lever

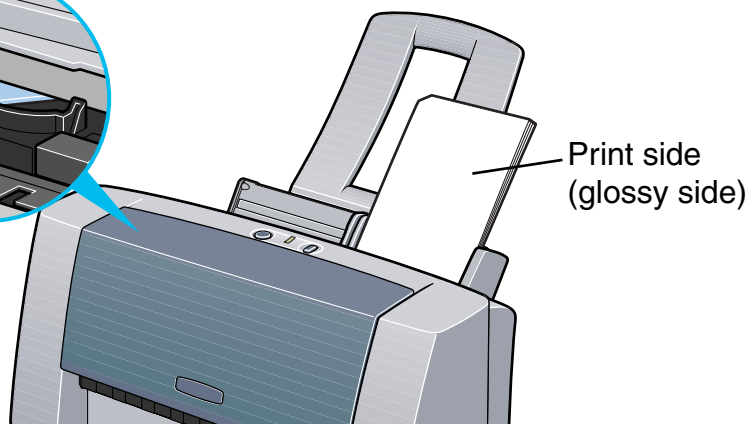
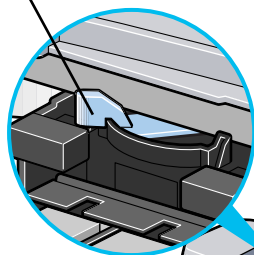

■ Printer Driver Settings

- **Media Type:** Photo Paper Pro
- **Page Size:** Select **Custom Size** and enter 4.67 x 8.5 in.

■ Applications Settings

Enter 4.31 x 6.31 in. for **Image Size**.

For details on how to specify the image size, refer to the application's user manual. You may not be able to specify the size of the image correctly in some applications.

■ Handling of Printed Output

Follow the instructions described in "[Photo Paper Pro PC-101S](#)".

■ Printable Area

 Printing Area

Transparencies CF-102

This film is ideal for printing presentation material for use with overhead projectors.

■ Loading

- Place one sheet of plain letter paper under the transparencies in the sheet feeder.
- Set the paper thickness lever to the left.
- A maximum of 30 sheets can be loaded at once.

Paper thickness lever

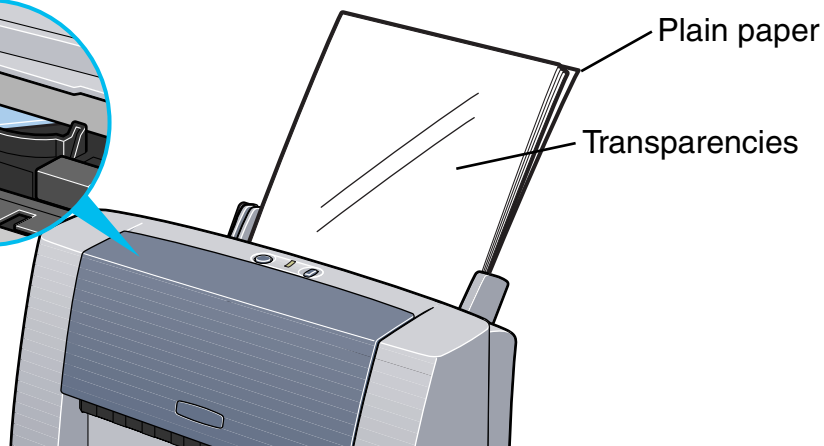
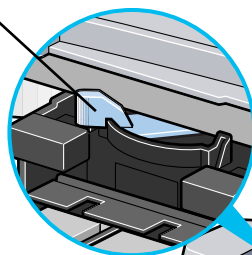

- Although you can print on either side of CF-102, best results can be obtained by printing on the side toward which it curls when held by the edge.

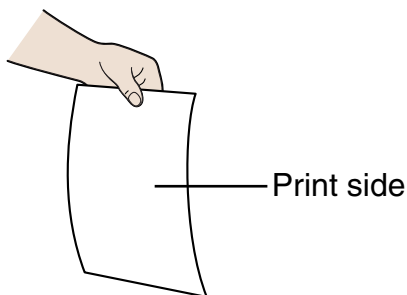

■ Printer Driver Settings

- **Media Type:** Transparency
- **Page Size:** Ensure that the setting matches the size set in the application.

■ Handling of Printed Output

- Remove each transparency as soon as it is printed.
- Do not touch the printed surface until the ink dries (approx. 15 minutes).

■ Printable Area



T-Shirt Transfers TR-201

This paper is used to produce iron-on transfers. The image is printed backward (mirror image) when **Media Type** is set to **T-Shirt Transfer** in the printer driver.

■ Loading

- Load only one sheet at a time.
- If the T-shirt transfer is curled, flatten it by curling it in the opposite direction.
- Load the paper with the side that does not have green lines facing up.
- Set the paper thickness lever to the right.

Paper thickness lever

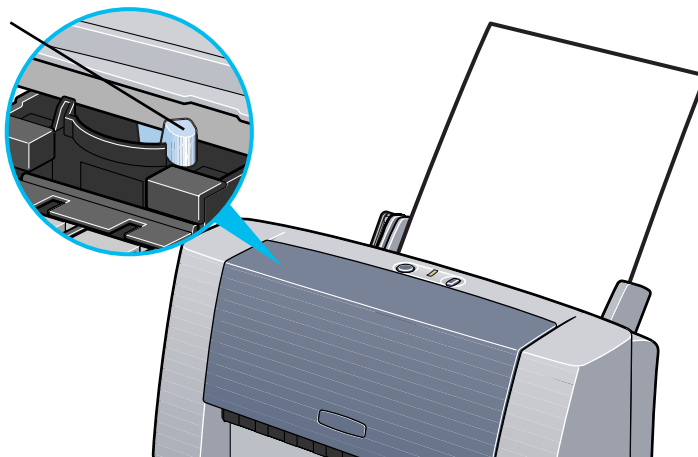

■ Printer Driver Settings

- **Media Type:** T-Shirt Transfer
- **Page Size:** Ensure that the setting matches the size set in the application.

■ Handling of Printed Output

- Remove each T-shirt transfer as soon as it is printed.
- The T-shirt transfer should be used as soon as possible. Refer to the supplied instructions for details on how to use the paper.

■ Printable Area

 Printing Area

Banner Paper

This is long paper that consists of consecutive sheets of letter-size paper, ideal for printing long posters or banners (up to six sheets long).

■ Preparation for Printing

- When tearing the banner paper, tear off one more sheet than you actually need to print.
- The maximum length for one print job is six sheets, so if you will be printing on six sheets, tear off a seven-sheet length.

■ Loading

- 1 Set the paper thickness lever to the right.
- 2 Load the banner paper with the printing side facing up. Gently fold the perforation between the first and second sheets.

Leave the rest of the paper folded up.

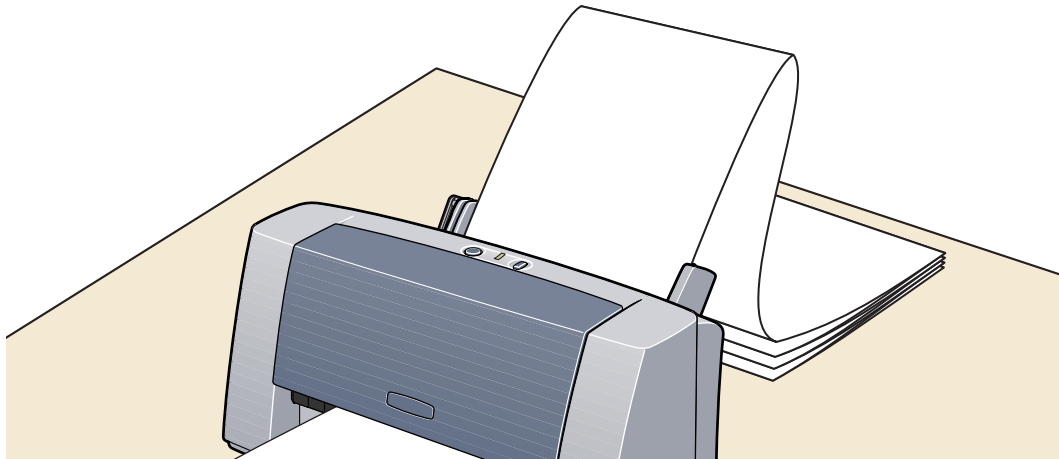

- 3 Place the printer where the printed banner output can hang over the edge of the table.

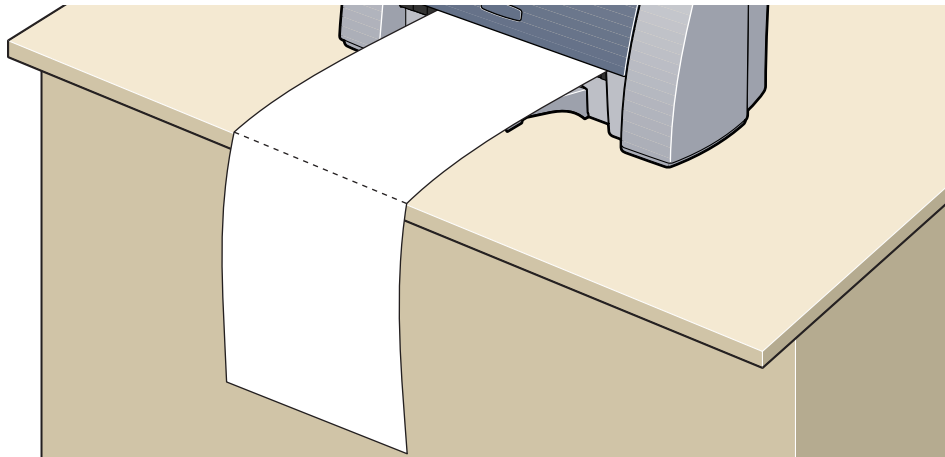

Ensure that the ink does not stain the table or floor.

■ Printer Driver Settings

- **Media Type:** Plain Paper
- **Page Size:** Letter
- **Printing Type:** Banner Printing
On a Macintosh, before creating the document, select **Banner Printing** in the **Page Setup** dialog box.
- **Copies:** Must be set to **1** to print correctly.

■ Printable Area

 Printing Area

Troubleshooting



- Cannot Install the Printer Driver
- Print Quality is Poor or Contains Errors
- Printer Does Not Start or Stops During Print Jobs
- Paper Does Not Feed Properly or Paper Jams
- The POWER Lamp Flashes Orange
- An Error Message is Displayed on the Screen
- Low Ink Warning Displays Ink Tank with '?'
- Problems Unique to Windows Windows
- Problems Unique to the Macintosh Macintosh

Cannot Install the Printer Driver

■ Follow the installation procedure correctly.

Install the printer driver carefully following the procedures described in the printed *Quick Start Guide*.

If the printer driver was not installed correctly, reinstall it. If you are using Windows, delete the printer driver before reinstalling it.

 [Uninstalling Printer Drivers](#)

Note  If the Installer was forcibly terminated due to an error in Windows, Windows may be unstable. This could prevent the printer driver from being installed. Restart the computer before reinstalling the printer driver.

■ Close any other applications before installation.

Sometimes the printer driver cannot be installed because another application is running.

- If the Installer for the printer driver does not start automatically when you insert the *Setup Software & User's Guide CD-ROM*, open the My Computer window, then double-click the CD-ROM icon.

Windows

Note ➤ If you choose to install from the **Run** command, specify the CD-ROM drive letter and the installation file name ("msetup.exe"). The CD-ROM drive letter is computer dependent.

- Confirm that there are no problems with the *Setup Software & User's Guide CD-ROM*.

In Windows, use Explorer to ensure that the CD-ROM can be read. In a Macintosh, check that the CD-ROM icon is visible. If there is a problem with the CD-ROM, contact the Customer Care Center.

Print Quality is Poor or Contains Errors

- Cannot Print to End of Job
- Colors are Unclear
- Meaningless Characters or Symbols are Printed
- Printing is Blurred/Colors are Wrong
- Straight Lines are Misaligned
- Printed Paper Curls or Ink Blots
- Back of Paper is Smudged
- Printed Surface is Scratched
- White Streaks
- Colors are Uneven or Streaked

Cannot Print to End of Job

- **Confirm that the Page Size setting matches the size of the paper loaded in the printer.**

First, check the **Page Size** setting in the application.

Next, check the **Page Size** setting in the Printer Properties dialog box for Windows, or the Page Setup dialog box for Macintosh.

- **Check the amount of the free space on the hard disk.**

You may need to increase the amount of free space by deleting any unnecessary files.

Colors are Unclear

- **Confirm the Media Type setting in the printer driver matches the type of paper loaded in the printer.**

If you are printing a photograph or an illustration from a Windows environment, also increase **Print Quality** on the **Main** tab.

If you are working in a Macintosh environment, select the **Photo** or **Graphic** icon for the **Print Mode** in the Print dialog box.

- **Confirm the specified ink tank is installed.**

When an ink tank runs out of ink, replace it with a new one.

Note ▶ Printed colors may not match screen colors perfectly due to basic differences in the methods used to produce colors. Color control settings and environmental differences can also affect how colors appear on the screen.

Meaningless Characters or Symbols are Printed

- **If the problem only occurs when printing a specific document, try editing the document, then printing it.**

If this does not resolve the problem, there may be a problem with your application program.

Printing is Blurred/Colors are Wrong

■ Print the nozzle check pattern to ensure that ink is output correctly.

If the nozzle check pattern does not print correctly, clean the printhead.

➡ [Printing the Nozzle Check Pattern](#)

➡ [Printhead Cleaning](#)

If the problem is not resolved after cleaning the printhead several times, replace either of the ink tanks. If print quality still remains poor, the printhead may be worn out. Contact the Customer Care Center.

Note ➤ Always ensure that you dispose of the protective cap from a printhead.

■ Ensure that you are printing on the correct side of the media.

You can only print on one side of certain media.

Straight Lines are Misaligned

■ Align the printhead.

Windows

- 1 Open the Printer Properties dialog box.
 [Opening the Printer Properties Dialog Box](#)
- 2 Click the **Maintenance** tab.
- 3 Click **Printhead Alignment**.
Follow the instructions on the screen.

Macintosh

- 1 Open the Page Setup dialog box.

The Page Setup dialog box can normally be opened by selecting **Page Setup** from the **File** menu.

- 2 Click **Utilities**.

- 3 Select **Test Print** from the drop-down menu, then click **Printhead Alignment**.

Follow the instructions on the screen.

Note ➤ Straight lines can become misaligned if the paper thickness lever has been moved. Aligning the printhead may also resolve this problem.

■ In the printer driver settings, select a higher print quality setting.

Windows

- 1 Open the Printer Properties dialog box.
 [Opening the Printer Properties Dialog Box](#)
- 2 Click the **Main** tab, then click **High** for the **Print Quality** setting.

Macintosh

- 1 Open the Print dialog box.

The Print dialog box can normally be opened by selecting **Print** from the **File** menu.
- 2 For **Print Mode**, select **Manual**, then click **Details**.
- 3 Click the **Quality** icon, then drag the **Print Quality** slider to the **Fine** end.

Printed Paper Curls or Ink Blots

- Use high resolution paper or photo paper to print images that require a lot of ink, such as pictures with intense colors, or photographs.
- Reduce the Intensity setting in the printer driver and try printing again.

Windows

- 1 Open the Printer Properties dialog box.
 - ➡ [Opening the Printer Properties Dialog Box](#)
- 2 Click the **Main** tab, then select **Manual** for **Color Adjustment**, then click **Set**.
- 3 Drag the **Intensity** slider to adjust the intensity.

Macintosh

1 Open the Print dialog box.

The Print dialog box can normally be opened by selecting **Print** from the **File** menu.

2 For **Print Mode**, select **Manual**, then click **Details**.

3 Click the **Color** icon, then drag the **Intensity** slider to set the intensity.

Back of Paper is Smudged

- If the next page prints before the ink is dry, enable the **Pause Page** printer driver setting.

You can either remove each printed sheet from the output tray as soon as it is printed, or enable **Pause Page** to pause after each sheet has printed.

Windows

- 1 Open the Printer Properties dialog box.
 - ➡ [Opening the Printer Properties Dialog Box](#)
- 2 Click the **Maintenance** tab.
- 3 Click **Custom Settings** to open the Custom Settings dialog box.
- 4 Select **Pause Page**, then click **Send**.

Macintosh

- 1 Open the Page Setup dialog box.

The Page Setup dialog box can normally be opened by selecting **Page Setup** from the **File** menu.

- 2 Click **Utilities**.
- 3 Select **Custom Settings** from the drop-down menu.
- 4 Select **Pause between pages**, then click **Send**.

■ **You may need to clean some of the printer's internal parts. To clean the inside of the printer, follow the procedure below.**

- 1 Load several sheets of letter-size plain paper into the printer's paper feeder.
- 2 Press and hold the RESUME/CANCEL button until the POWER lamp flashes three times, then release the button. A test page will print.
- 3 Repeat this operation until there are no more smudges on the test page.

Printed Surface is Scratched

■ Ensure that you are using suitable paper.

- The paper weight must be less than 28 lb.

If you use paper heavier than 28 lb., the printhead may scratch the printed surface. Clean the printhead first, then print with the correct paper.

- The paper must not be curled.

This problem can be resolved by simply turning the paper over.

■ When printing on thick paper, set the paper thickness lever to the right.

This widens a gap between the printhead and the paper.

If the paper gets scratched when printing on plain paper, try setting the paper thickness lever to the right. A message will display saying that the position of the lever is incorrect. Ignore the message and continue printing.

■ Reduce the Intensity setting in the printer driver and try printing again.

When printing an image with high intensity, especially on plain paper, the paper may absorb too much ink and become wavy. This may cause the printed surface to become scratched.

Windows

- 1 Open the Printer Properties dialog box.
 [Opening the Printer Properties Dialog Box](#)
- 2 Click the **Main** tab, then select **Manual** for **Color Adjustment**, then click **Set**.
- 3 Drag the **Intensity** slider to adjust the intensity.

Macintosh

- 1 Open the Print dialog box.
The Print dialog box can be opened by clicking **Print** from the **File** menu.
- 2 For **Print Mode**, select **Manual**, then click **Details**.
- 3 Click the **Color** icon and drag the **Intensity** slider to set the intensity.

■ **Ensure that you are printing within the recommended printing area.**

 [Printing Area](#)

White Streaks

■ Print the nozzle check pattern to check the ink output.

If a specific color does not print in the nozzle check pattern, clean the printhead.

➡ [Printing the Nozzle Check Pattern](#)

➡ [Printhead Cleaning](#)

The problem can also be resolved by aligning the printhead. For details on printhead alignment, refer to "[Straight Lines are Misaligned](#)".

Colors are Uneven or Streaked

■ Increase the print quality setting in the printer driver settings.

Windows

- 1 Open the Printer Properties dialog box.
 [Opening the Printer Properties Dialog Box](#)
- 2 Click the **Main** tab, then click **High** for the **Print Quality** setting.

Macintosh

- 1 Open the Print dialog box.

The Print dialog box can normally be opened by clicking **Print** from the **File** menu.
- 2 For **Print Mode**, select **Manual**, then click **Details**.
- 3 Click the **Quality** icon, then drag the **Print Quality** slider to the **Fine** end.

■ Set the halftoning method to Diffusion in the printer driver settings.

Windows

- 1 Open the Printer Properties dialog box.
 [Opening the Printer Properties Dialog Box](#)
- 2 Click the **Main** tab, select **Custom** for the **Print Quality** setting, then click **Set**.
- 3 Click **Diffusion** for the **Halftoning** setting.

Macintosh

- 1 Open the Print dialog box.

The Print dialog box can normally be opened by clicking **Print** from the **File** menu.
- 2 For **Print Mode**, select **Manual**, then click **Details**.
- 3 Click the **Quality** icon, then click **Diffusion** for the **Halftoning** setting.

Printer Does Not Start or Stops During Print Jobs

- Printing Does Not Start
- Printing Stops Before It is Completed
- Printer Moves But Does Not Print
- Printhead Holder Does Not Move

Printing Does Not Start

■ Ensure that the printer is turned on.

If the POWER lamp is off, press the POWER button.

If the POWER lamp is flashing green, the printer is initializing. Wait until the POWER lamp stops flashing.

Note ➤ When printing a large amount of data, such as a photograph or illustration, the printer may take longer than usual to begin printing. While the POWER lamp is flashing, the computer is processing the data and sending it to the printer. Wait until the green lamp stops flashing and printing begins.

■ Ensure that the printer is securely connected to the computer.

Note ➤ If you are using a switch box or other device, remove and reconnect the printer directly to the computer. Try printing again.
If printing is successful, there may be a problem with the device. Also, there could be a problem with the cable(s). Replace the cable(s) and try printing again.

■ Ensure that the correct printer driver is selected.

In Windows, ensure that **Canon S300** is selected in the **Print** dialog box.

In Macintosh, ensure that **S300** is selected in the **Chooser**.

Note ➤ In Windows, you can set the Canon S300 as the default printer.

■ Ensure that the printer port is set correctly. Windows

Set "USBPRNnn" or "USBnnn" ("n" represents a number) as the printer port.

- 1 Click **Start**, then select **Settings, Printers**.
- 2 Select the **Canon S300** icon.
- 3 Open the **File** menu and select **Properties**.
- 4 Click the **Details** tab (or **Ports** tab) and set the printer port.

Printing Stops Before It is Completed

■ Check the status of the POWER lamp.

When the POWER lamp is flashing green, the printer is processing data. Printing a large amount of data, such as a photograph or illustration, takes time for the computer to process, during which the printer may appear to not be functioning.

In addition, when continuously printing material that uses a large amount of black ink on plain paper, the printer will sometimes pause. In either case, wait until the processing is complete.

■ Halt the print job and turn the printer off for at least 15 minutes to cool the printhead.

The printhead can overheat when continuously printing for a long time. To protect the printhead, the printer will sometimes pause automatically at a line break before resuming. In this event, interrupt the print job at a convenient time, then turn the printer off for at least 15 minutes.

Furthermore, when continuously printing graphics or photos with intense colors, printing may stop to protect the printhead. In this case, printing will not resume. Turn the printer off and wait at least 15 minutes before turning the printer back on and reprinting the job.

Caution ► The area around the printhead inside the printer can become extremely hot. Do not touch the printhead or nearby components.

Printer Moves But Does Not Print

■ Print the nozzle check pattern to ensure that ink is output correctly.

If the nozzle check pattern does not print correctly, clean the printhead.

➡ [Printing the Nozzle Check Pattern](#)

➡ [Printhead Cleaning](#)

If the problem is not resolved by cleaning the printhead several times, replace either of the ink tanks. If print quality still remains poor, the printhead may be worn out. Contact the Customer Care Center.

Printhead Holder Does Not Move

■ **Ensure that the printer is turned on.**

The printhead holder will not move unless the power is on. If the POWER lamp is off, close the front cover and turn the power on.

If the POWER lamp is flashing green, the printer is initializing. When the POWER lamp stops flashing, open the front cover again.

■ **If the front cover has been left open for a while, close and reopen it.**

If the front cover is left open for more than 10 minutes, the printhead holder moves to the right to prevent the printhead from drying out. Close and reopen the front cover to return the holder to the center position.

Paper Does Not Feed Properly or Paper Jams

- Paper Does Not Feed Properly
- Envelopes or Postcards Do Not Feed Properly
- Paper Jams

Paper Does Not Feed Properly

■ Confirm the paper conditions.

- The paper is not too thick (less than 28 lb.).
- The number of sheets loaded does not exceed the recommended level.
- The paper is not creased, curled or wrinkled.

 [Compatible Media Types](#)

■ Ensure that the left edge of the paper just touches the paper guide.

■ When printing envelopes, refer to "[Envelopes](#)" in "[Printing Media](#)", and prepare the envelopes before printing.

Once you have prepared the envelopes, load them in the printer in portrait orientation. If the envelopes are placed in landscape orientation, they may not feed properly.

■ When using transparencies, load one sheet of plain paper in the printer first, then place the transparencies on top of it.

The last transparency may not feed properly unless there is a sheet of plain paper beneath it.

Envelopes or Postcards Do Not Feed Properly

If envelopes or postcards do not feed properly even after removing curl, clean the paper feed roller.

- 1 Ensure that the printer is on and no paper is loaded in the printer.
- 2 Press and hold the RESUME/CANCEL button, then release as the POWER lamp flashes three times.

The paper roller will rotate ten times as it cleans.

Repeat this three times.

- 3 Load a sheet of letter-size plain paper in the printer.
- 4 Press and hold the RESUME/CANCEL button, then release as the POWER lamp flashes three times. The sheet will feed through.

Repeat this three times.

If the printer still does not feed the envelopes or the postcards through after the cleaning, repeat these procedures again.

Paper Jams

Remove the paper according to the following procedure.

- 1 Slowly pull the paper out, either from the sheet feeder or from the paper output slot, whichever is easier.

If the paper tears and a piece remains inside the printer, open the front cover and remove it.

If you cannot pull the paper out, turn the printer off and turn it back on. The paper will be ejected automatically.

- 2 After removing all paper, close the front cover.

- 3 Reload the paper into the printer and press the RESUME/CANCEL button.

Note ➤ When reloading the paper into the printer, refer to "[Paper Does Not Feed Properly](#)" to confirm that you are using the correct paper and are loading it into the printer correctly.

The POWER Lamp Flashes Orange

An error has occurred in the printer. The number of orange flashes between green flashes indicates the type of error, as outlined below. Check the cause and take the appropriate action.

■ Two orange flashes: Out of paper, paper jam or paper feed error

Replace the paper correctly and press the RESUME/CANCEL button.

If paper has jammed in the printer, clear the jam and press the RESUME/CANCEL button.

■ Three orange flashes: Paper jam

If paper has jammed in the printer, clear the jam, replace the paper in the printer correctly and press the RESUME/CANCEL button.

 [Paper Jams](#)

■ Six orange flashes: No printhead installed

Install a printhead. If the error persists after the printhead has been correctly installed, contact the Customer Care Center.

■ Seven orange flashes: Defective printhead

Contact the Customer Care Center.

■ Eight orange flashes: Waste ink tank almost full

The printer has a built-in waste ink tank for the ink used during printhead cleaning. Eight flashes indicates that the waste ink tank is nearly full. Press the RESUME/CANCEL button to cancel the error so you can continue printing. Before the waste ink tank becomes completely full, contact the Customer Care Center to have the waste ink tank replaced.

Note ► Canon recommends that you call the Customer Care Center for service as soon as this error occurs. Once the waste ink tank becomes completely full, printing will be no longer possible.

- **POWER lamp flashes alternate green and orange:
An error has occurred that may require you to contact the Customer Care Center.**

Turn the printer off and unplug the printer from the power supply. Plug the printer back in and turn the printer back on. If the problem remains, contact the Customer Care Center.

An Error Message is Displayed on the Screen

- Error Writing to USBxxx

Windows

- Application Error or General Protection Fault

Windows

- Other Error Messages

Windows

- Other Error Messages

Macintosh

Error Writing to USBxxx

Windows

■ Ensure that the printer is turned on.

If the POWER lamp is off, turn the printer on.

If the POWER lamp is flashing green, the printer is initializing. Wait until the POWER lamp stops flashing.

■ Ensure that the printer is securely connected to the computer.

Note ➤ If you are using a switch box or other device, remove and reconnect the printer directly to the computer and try printing again. If printing is now successful, there may be a problem with the device. Also there could be a problem with the cable(s). Replace the cable(s) and try printing again.

■ If spooling is enabled, disable it to send the print data directly to the printer, then try printing again.

1 Open the Printer Properties dialog box from the **Start** menu.

➡ Opening the Printer Properties dialog box directly from the Start menu

- 2 Click the **Details** tab, click **Spool Settings**, then select **Print directly to the printer**.
In Windows 2000 or Windows XP, click the **Advanced** tab, then click **Print directly to the printer**.

■ Verify the USB port status.

- 1 Right-click **My Computer** and select **Properties**.
- 2 Click the **Device Manager** tab, double-click **Universal Serial Bus Controller**, then double-click **Canon S300**.
In Windows 2000 or Windows XP, click **Device Manager**, click **Universal Serial Bus controller** on the **Hardware** tab, then double-click **USB Printing Support**.
- 3 Click the **General** tab, then check if there is any indication of a problem with the device. In Windows 2000 and Windows XP, open the **USB Printing Support Properties** dialog box to see the **General** tab.

If an error has occurred, follow the instructions in the Troubleshooting section of the printed *Quick Start Guide*.

■ **Ensure that the printer port setting corresponds to the printer interface connection.**

- 1 Open the Printer Properties dialog box from the **Start** menu.
 - ➡ Opening the Printer Properties dialog box directly from the Start menu
- 2 Click the **Details** tab (or **Ports** tab), then select **USBPRNnn (Canon S300)** or **USBnnn (Canon S300)** ("n" represents a number) from the **Print to the following port** drop-down list.

■ **There may be a problem in the printer driver. Uninstall the printer driver and reinstall it.**

- ➡ Uninstalling Printer Drivers

Application Error or General Protection Fault

Windows

- **Ensure that the application program you are using is intended for your operating system.**

For example, if you attempt to print with a Windows 3.1 application under Windows 98, the application may not function correctly and an error may occur. Use an application program intended for your operating system.

- **If other applications are running, close them to increase available memory, then try printing again.**

- **Ensure that enough memory is allocated to the application.**

Refer to the memory requirements of your application.

■ **Check the amount of free space on the hard disk.**

You may need to increase the amount of free space by deleting any unnecessary files.

■ **If the problem occurs only when printing a specific document, try editing the document, then printing it.**

If this resolves the problem, there may have been a problem in the original document. If the same problem occurs with the edited document, contact the manufacturer of your application.

■ **There may be a problem in the printer driver. Uninstall the printer driver and reinstall it.**

 [Uninstalling Printer Drivers](#)

Other Error Messages

Windows

■ If the BJ Status Monitor is displayed, follow the instructions on screen.

If an error occurs during printing, the BJ Status Monitor displays the error on the **Printer Status** tab. Follow the instructions on the screen.

In Windows 98 or Windows Me, click the **Guide** tab for actions to be taken in response to the error.

Refer to "[Low Ink Warning Displays Ink Tank with '?'](#)" for more information.

■ **If one of the following messages is displayed outside of the BJ Status Monitor:**

Could not spool successfully due to insufficient disk space

Increase the amount of free space on the disk by deleting any unnecessary files.

Could not spool successfully due to insufficient memory

Increase available memory by closing any other applications currently running.

Printer driver could not be found

Uninstall the printer driver and reinstall it.

 [Uninstalling Printer Drivers](#)

Background printing failed (Windows 98/Windows Me only)

Restart Windows and try printing again.

Could not print Application name – File name

Try printing again once the current job is finished.

Other Error Messages

Macintosh

- If a message with the format "Error No.: Xnnn" (where "X" represents a letter and "n" represents a number) is displayed:

Error No.: X202

Not enough memory for printing. Increase available memory by closing any other applications currently running.

Error No.: X203

There is a problem with the printer driver. Uninstall the printer driver and reinstall it.

 [Uninstalling Printer Drivers](#)

Error No.: X300

Ensure that the power is on, and that the printer and the computer are securely connected. If the problem remains, verify the Chooser setting.

- 1 In the Apple menu, select **Chooser**.
- 2 Click the **S300** icon and ensure that S300 is selected as the **Connected to** destination.

If it is not selected, select it.

If the problem remains, delete all unnecessary documents from the Extensions and Control Panels folder.

Low Ink Warning Displays Ink Tank with '?'

The ink level of an ink tank displayed with a '?' is not synchronized with its ink counter.

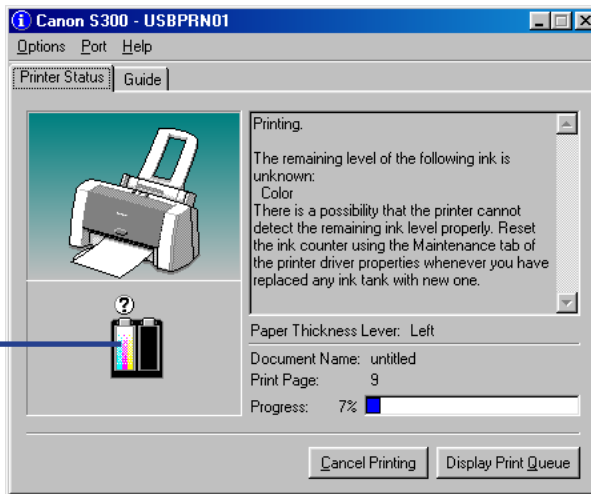

The color ink level may not be indicated correctly.

BJ Status Monitor (Windows)

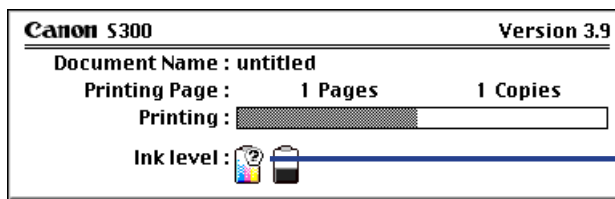

The color ink level may not be indicated correctly.

BJ Status Dialog (Macintosh)

Macintosh

Note ▶ When background printing is enabled, the low ink warning displays on the BJ Print Monitor (Macintosh).

➡ [BJ Print Monitor](#)

■ **Reset the ink counter from the printer driver when you replace the ink tank.**

➡ [Resetting Ink Counter](#)

■ **Turn the low ink warning off until you replace the ink tank to stop the warning message.**

Windows

1 Ensure that the printer is on and open the Printer Properties dialog box.

➡ [Opening the Printer Properties Dialog Box](#)

2 Click the **Maintenance** tab, click **Low Ink Warning Setting** icon.

3 Click to clear the check box for **Display low ink warning**, then click **Send**.

Macintosh

- 1 Ensure that the printer is on and open the Page Setup dialog box.
The Page Setup dialog box can normally be opened by selecting **Page Setup** in the **File** menu.
- 2 Click the **Utilities** icon to open the Printer Utilities dialog box.
- 3 Select **Remaining ink level setting** from the drop-down menu and click the **Low Ink Warning Setting** icon.
- 4 Click to clear the check box for **Display low ink warning**, then click **Send**.

Note ➤ Also refer to "[Enabling Low Ink Warning](#)" to display the ink level correctly.

Problems Unique to Windows

- The BJ Status Monitor is Not Displayed
- Cannot Print in Background (Windows 98/Windows Me only)

The BJ Status Monitor is Not Displayed

■ Ensure that "Enable bi-directional support for this printer" is selected.

- 1 Open the Printer Properties dialog box from the **Start** menu.
 - ➡ Opening the Printer Properties dialog box directly from the Start menu
- 2 Click the **Details** tab, click **Spool Settings** and select **Enable bi-directional support for this printer**.

In Windows 2000 or Windows XP, select **Enable bi-directional support** on the **Ports** tab.

Cannot Print in Background (Windows 98/Windows Me only)

■ Check the amount of free space on the hard disk.

Background printing requires a certain amount of disk space. You may need to delete unnecessary files, or disable background printing.

■ Ensure that background printing is enabled.

- 1 Open the Printer Properties dialog box.
 - ➡ [Opening the Printer Properties Dialog Box](#)
- 2 Click the **Page Setup** tab, then **Printer control**, then **Background Printing**.

Problems Unique to the Macintosh

- Jagged Text or Graphics, or Banded Gradations
- Cannot Print in Background

Jagged Text or Graphics, or Banded Gradations

■ Ensure that your application supports Quick Draw.

If you are using a PostScript-compatible application, printed text and lines may appear jagged and gradations may appear banded. As the S300 is not a PostScript printer but a Quick Draw printer, use an application compatible with Quick Draw for printing.

Cannot Print in Background

■ Ensure that background printing is enabled.

1 In the Apple menu, select **Chooser**.

2 Set **Backgrounding** to **On**.

■ Check the amount of free space on the hard disk.

Background printing requires a certain amount of disk space.

You may need to remove unnecessary files, or disable background printing.

Specifications



Printing method:

Bubble Jet on-demand

Printing resolution:

2400 (horizontal) × 1200 (vertical) dpi max.

Print speed (printing with Canon standard pattern):

Black printing	Draft:	11 ppm
	Standard:	9.5 ppm
Color printing	Draft:	7.5 ppm
	Standard:	4.1 ppm

Print direction:

Bi-directional

Print width:

8.0 in. max.

Resident print control mode:

Canon extended mode

Receive buffer:

56 KB

Interface:

USB 1.10-compatible

Interface connector:

USB standard Series B receptacle (USB interface)

Recommended printer cable:

Material: AWG28 (data wiring pair) or AWG20 to 28 (distribution pair)

Type: Twisted-pair shielded cable

Length: Up to 6.4 ft.

Connectors: USB standard Series B pluggable

Acoustic noise level:

Approx. 45 dB (A) (in the highest print quality mode)

Operating environment:

Temperature: 41 to 95°F

Humidity: 10 to 90%RH (no condensation)

Storage environment:

Temperature: 32 to 95°F

Humidity: 5 to 90% RH (no condensation)

Power supply:

USA/Canada AC 120 V, 60 Hz

Power consumption:

Standby: Approx. 2 W
Printing: Approx. 30 W

Dimensions (without a paper rest and paper output tray):

15.7 (W) × 9.8 (D) × 7.3 (H) in.

Weight:

Approx. 7.5 lb.

■ Feed method:

Continuous feed through auto sheet feeder

For plain paper, envelopes, High Resolution Paper, Glossy Photo Paper, High Gloss Photo Film, Glossy Photo Cards, Photo Paper Pro, Transparencies, T-shirt Transfers, Banner Paper

■ Sheet feeder capacity:

Plain paper (17 lb.)	100 sheets max.
High Resolution Paper	80 sheets max.
Envelopes	10 pieces max.
Glossy Photo Paper	10 sheets max.
High Gloss Photo Film	1 sheet
Glossy Photo Cards	20 sheets max.
Photo Paper Pro PR-101	1 sheet
Photo Paper Pro PC-101S	20 sheets max.
Transparencies	30 sheets max.
T-Shirt Transfers	1 sheet
Banner Paper	1 sheet

■ Ordinary print media:

Regular size: Letter, legal, A4, A5, B5, US Com.#10, European DL

Custom size: width: 3.54 to 8.5 in.
height: 4.72 to 23.0 in.

Weight: 17 to 28 lb.

Canon Special media:

High Resolution Paper	HR-101N
Glossy Photo Paper	GP-301N/GP-301
High Gloss Photo Film	HG-201
Glossy Photo Cards	FM-101
Photo Paper Pro	PR-101
Photo Paper Pro	PC-101S
Transparencies	CF-102
T-Shirt Transfers	TR-201
Banner Paper	

■ Graphic image printing:

Data format: Canon extended mode: Raster image format

Resolution: Canon extended mode: 300, 600, 1200, 2400 dpi

■ Printhead:

Black: 320 nozzles (600 dpi)

Cyan, Magenta, Yellow: 128 nozzles per each color (600 dpi)

■ Ink Tanks:

Capacity:

Black (BCI-24 Black)	approx. 300 ^{*1} , approx. 580 ^{*2}
Color (BCI-24 Color)	approx. 170 ^{*2}

*1 1500 characters per page, normal text, at standard and plain paper mode with Windows 98/Windows Me

*2 Based on printing the ISO JIS-SCID No.5 pattern at standard and plain paper mode with Windows 98/Windows Me

■ Printer driver operating environment:

IBM PC/AT-compatible computer running on Windows 98, Windows Me, Windows 2000, Windows XP or Macintosh computers with USB interface running on Mac OS 8.6 - Mac OS 9.X

■ Hard disk space:

Approx. 15 MB to install on Windows 98 and Windows Me, 30 MB on Mac OS, or approx. 25 MB on Windows 2000 and Windows XP (including temporary files)

Note ➤ Use the system under the following operating environments:

Windows

Computer with Microsoft Windows 98, Windows Me, Windows 2000 or Windows XP which is pre-installed by a computer manufacturer on purchase. USB port operation also needs to be assured by the manufacturer.

Macintosh

Macintosh computers with USB and Mac OS 8.6 - Mac OS 9.X, which is pre-installed by a computer manufacturer on purchase.

Specifications subject to change without prior notice.

■ Printing Area

To ensure the best print quality, the printer allows a margin along each edge of media.

Printing area (dark blue): Canon recommends that you print within this area.



Printable area (light blue): The area where it is possible to print. However, printing in this area can adversely affect the print quality or the paper feed precision. ()

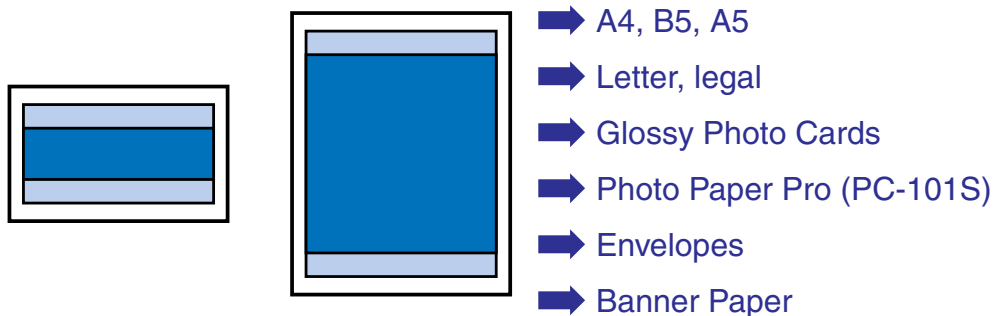

A4, B5, A5

Size	Printable Area (width x height)
A4	8.0 × 11.4 in. (203.2 × 289.0 mm)
B5	6.9 × 9.8 in. (175.2 × 249.0 mm)
A5	5.6 × 7.9 in. (141.2 × 202.0 mm)

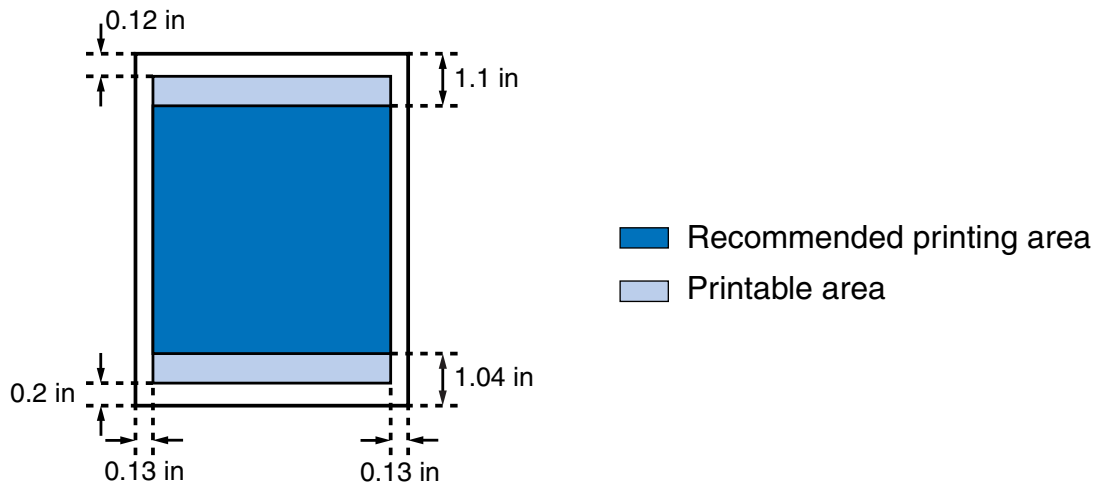

Letter, legal

Size	Printable Area (width x height)
Letter	8.0 × 10.7 in.
Legal	8.0 × 13.7 in.

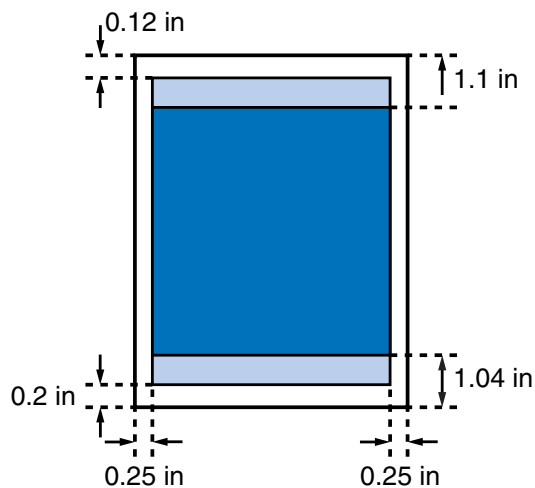

■ Recommended printing area

■ Printable area

Glossy Photo Cards

Size	Printable Area (width x height)
Glossy Photo Card	4.3 × 6.3 in.

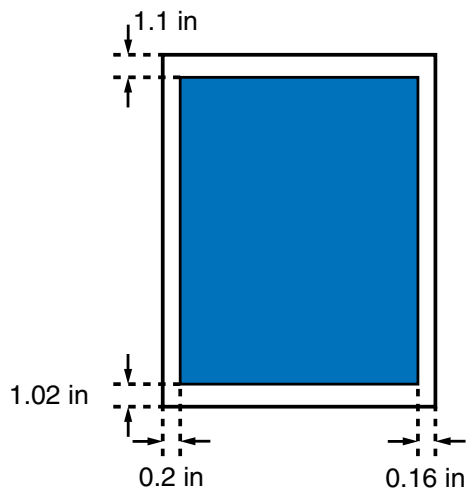



 Recommended printing area
(Printable area is the same.)

Photo Paper Pro (PC-101S)

Size	Printable Area (width x height)
Photo Paper Pro PC-101S	4.3 × 6.3 in.

Note ➤ The printing area of Photo Paper Pro PR-101 is identical to that of A4 size paper. For details, refer to "A4, B5, A5".

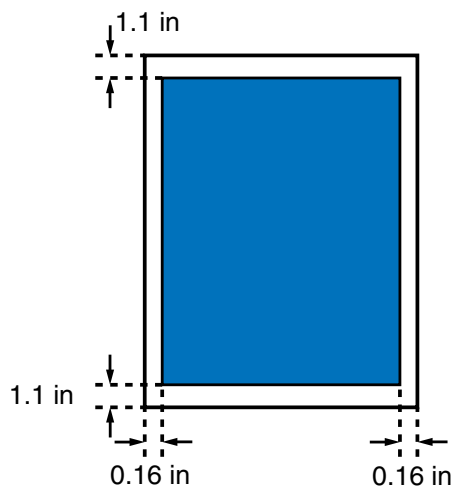

 Recommended printing area
(Printable area is the same.)

Envelopes

Size	Printable Area (width x height)
US Com. #10	8.3 × 3.9 in.
European DL	7.5 × 4.1 in. (190.5 × 103.2 mm)

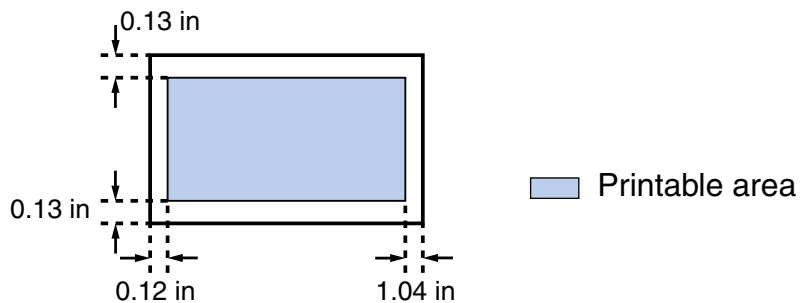

Banner Paper

Size	Printable Area (width x height)
Banner Paper	Letter: 8.0 × 65.7 in.

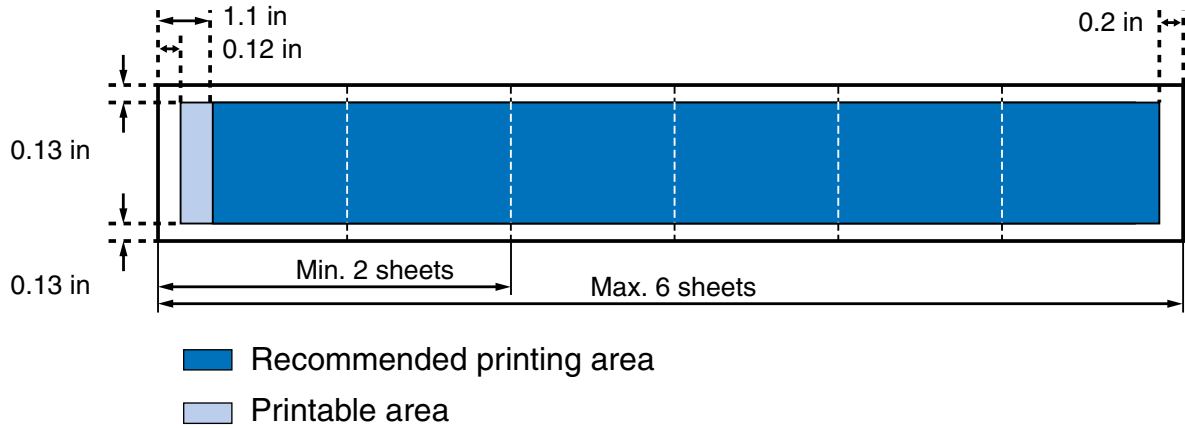

Index



A

Application Error 154

B

Background printing (Macintosh) 57

Background printing (Windows) 164

Banner Paper 114

BCI-24 Black 67

BCI-24 Color 67

BJ Print Monitor (Macintosh) 57

BJ Status Dialog (Macintosh) 82, 159

BJ Status Monitor (Macintosh) 63

BJ Status Monitor (Windows) 35, 82, 156, 159, 163

C

Canceling a Print Job (Macintosh) 59

Cancelling a Print Job (Windows) 38

Chooser (Macintosh) 57

Cleaning 33, 44, 76

Client (Macintosh) 61

Compatible Media Types 92

D

Deep Cleaning	33, 79
Duplex Printing	26, 55

E

Enabling Low Ink Warning	81
Envelopes	94
Error Message	150, 156, 158

F

Front cover	15, 142
-------------------	---------

G

Gamma Correction (Macintosh)	53
General Protection Fault	154
Glossy Photo Cards FM-101	104
Glossy Photo Paper GP-301N/GP-301	100

H

High Gloss Photo Film HG-201	102
High Resolution Paper HR-101N	98

I

Ink Counter Reset	34, 85
Ink Tank	66, 67

L

Low Ink Warning	34, 81
-----------------------	--------

Low Ink Warning Displays Ink Tank with '?'	159
M	
Media Type (Macintosh)	46
Media Type (Windows)	23
N	
Network (Macintosh)	60
Nozzle Check Pattern	75
O	
Opening the Printer Properties Dialog Box (Windows)	20
P	
[Page Setup] Dialog Box (Macintosh)	42
Page Size (Windows)	25
paper feed roller	96, 145
Paper Guide	15
Paper Jams	146
Paper Output Tray	15
Paper Rest	15
Paper Size (Macintosh)	42
Paper Thickness Lever	17
Photo Optimizer PRO (Macintosh)	51
Photo Optimizer PRO (Windows)	30
Photo Paper Pro PC-101S	108
Photo Paper Pro PR-101	106
PICT File (Macintosh)	55

POWER Button	18
POWER Lamp	18, 147
Print Advisor (Windows)	24
[Print] Dialog Box (Macintosh)	46
Print Mode (Macintosh)	46
Print server (Macintosh)	60
Printable area	175
Printer Driver (Macintosh)	40
Printer Driver (Windows)	19
Printer port	153
Printer Properties Dialog Box (Windows)	20, 22
Printhead Holder	17
Printhead Lock Lever	17
Printing Area	175
Printing the Nozzle Check Pattern	72

R

Replacing an Ink Tank	67
Resetting Ink Counter	85
RESUME/CANCEL Button	18

S

Sheet Feeder	15
Simulate illustration (Macintosh)	50
Simulate Illustration (Windows)	29
Specifications	168

T

Transparencies CF-102 110
Transporting the Printer 87
T-Shirt Transfers TR-201 112

U

Uninstalling Printer Drivers (Macintosh) 64
Uninstalling Printer Drivers (Windows) 39
USB Port 16, 152

V

Vivid Photo 30, 51

W

When to Replace Ink Tank and Maintain Printhead 66